



SERVICE MANUAL

VHF AIR BAND TRANSCEIVER

IC-A110
IC-A110EURO

INTRODUCTION

This service manual describes the latest service information for the **IC-A110**, **IC-A110EURO** VHF AIR BAND TRANSCEIVER at the time of publication.

MODEL	VERSION	SYMBOL
IC-A110	General	GEN
	General-1	GEN-1
	U.S.A.	USA
	U.S.A.-1	USA-1
	Australia	AUS
IC-A110EURO	Europe	EUR
	Europe-1	EUR-1

To upgrade quality, any electrical or mechanical parts and internal circuits are subject to change without notice or obligation.



ORDERING PARTS

Be sure to include the following four points when ordering replacement parts:

1. 10-digit order numbers
2. Component part number and name
3. Equipment model name and unit name
4. Quantity required

<SAMPLE ORDER>

1130008830 S.IC TB31207AFN IC-A110 MAIN UNIT 5 pieces
8810009130 Screw BT M3x12 NI-ZU IC-A110 Bottom cover 10 pieces
Addresses are provided on the inside back cover for your convenience.

DANGER

NEVER connect the transceiver to an AC outlet or to a DC power supply that uses more than 16 V. This will ruin the transceiver.

DO NOT expose the transceiver to rain, snow or any liquids.

DO NOT reverse the polarities of the power supply when connecting the transceiver.

DO NOT apply an RF signal of more than 20 dBm (100 mW) to the antenna connector. This could damage the transceiver's front end.

REPAIR NOTES

1. Make sure a problem is internal before disassembling the transceiver.
2. **DO NOT** open the transceiver until the transceiver is disconnected from its power source.
3. **DO NOT** force any of the variable components. Turn them slowly and smoothly.
4. **DO NOT** short any circuits or electronic parts. An insulated tuning tool **MUST** be used for all adjustments.
5. **DO NOT** keep power ON for a long time when the transceiver is defective.
6. **DO NOT** transmit power into a signal generator or a sweep generator.
7. **ALWAYS** connect a 50 dB to 60 dB attenuator between the transceiver and a deviation meter or spectrum analyzer when using such test equipment.
8. **READ** the instructions of test equipment thoroughly before connecting equipment to the transceiver.

TABLE OF CONTENTS

SECTION 1 SPECIFICATIONS

1 - 1	IC-A110	1 - 1
1 - 2	IC-A110EURO	1 - 2

SECTION 2 INSIDE VIEWS

2 - 1	IC-A110	2 - 1
2 - 2	IC-A110EURO	2 - 2

SECTION 3 CIRCUIT DESCRIPTION

3 - 1	RECEIVER CIRCUITS	3 - 1
3 - 2	TRANSMITTER CIRCUITS	3 - 3
3 - 3	PLL CIRCUITS	3 - 4
3 - 4	POWER SUPPLY CIRCUITS	3 - 5
3 - 5	PORT ALLOCATIONS	3 - 5

SECTION 4 ADJUSTMENT PROCEDURES

4 - 1	PREPARATION	4 - 1
4 - 2	PLL ADJUSTMENTS	4 - 3
4 - 3	RECEIVER ADJUSTMENTS	4 - 5
4 - 4	TRANSMITTER ADJUSTMENTS	4 - 7

SECTION 5 PARTS LIST

SECTION 6 MECHANICAL PARTS AND DISSASSEMBLY

SECTION 7 SEMI-CONDUCTOR INFORMATION

SECTION 8 BOARD LAYOUTS

8 - 1	FRONT UNIT (IC-A110)	8 - 1
8 - 2	MAIN UNIT (IC-A110)	8 - 3
8 - 3	FRONT UNIT (IC-A110EURO)	8 - 5
8 - 4	MAIN UNIT (IC-A110EURO)	8 - 7

SECTION 9 BLOCK DIAGRAM

SECTION 10 VOLTAGE DIAGRAM

10 - 1	FRONT UNIT	10 - 1
10 - 2	MAIN UNIT	10 - 2

SECTION 1 SPECIFICATIONS

1-1 IC-A110 SPECIFICATIONS

■ GENERAL

- Frequency coverage : 118.000–136.975 MHz
- Channel spacing : 25 kHz [GEN], [GEN-1]
25 kHz/8.33 kHz [USA], [USA-1]
- Type of emission : AM (6K00A3E)
- Number of memory channels : 20 channels
- Antenna connector : SO-239 (50 Ω)
- Power supply requirement : 13.75 V DC or 27.5 V DC (negative ground)
- Current drain (at 13.75 V DC) : Transmit 5.0 A
Receive max. audio output 4.0 A
stand-by 500 mA
- Frequency stability : ±5 ppm
- Usable temperature range : –30°C to +60°C; –22°F to +140°F
- Dimensions (projections not included) : 150(W) × 50(H) × 180(D) mm; 5²⁹/₃₂(W) × 1³¹/₃₂(H) × 7³/₃₂(D) in
- Weight : 1.5 kg; 3 lb 5 oz

■ TRANSMITTER

- RF output power (at 13.75 V DC) : 9.0 W (typical)
- Modulation system : Last stage modulation
- Input impedance : 600 Ω
- Modulation limiting : 70–100 %
- Audio harmonic distortion : Less than 10 % (at 85 % modulation)
- Ham and noise ratio : More than 40 dB
- Spurious emissions : –16 dBm or less (except ±62.5 kHz of operating frequency)
- Antenna requirements : Standard 50 Ω antenna with a VSWR < 3 : 1

■ RECEIVER

- Receive system : Double conversion superheterodyne system
- Intermediate frequencies : 1st 38.85 MHz
2nd 450 kHz
- Sensitivity : Less than 1 μV at 6 dB S/N
- Squelch sensitivity : Less than 0.35 μV at threshold
- Selectivity :

At 25 kHz channel spacing	
±8 kHz	Less than 6 dB
±17 kHz	Less than 40 dB
±25 kHz	Less than 60 dB

At 8.33 kHz channel spacing	
±2.778 kHz	Less than 6 dB
±7.37 kHz	Less than 60 dB

- Spurious response rejection ratio : More than 74 dBμ
- Hum and noise : More than 25 dB
- Audio output power (at 13.75 V DC) : Ext SP More than 10.0 W at 10 % distortion with an 8 Ω load
Side tone More than 100 mW at 10 % distortion with an 500 Ω load
- Audio output impedance : Ext SP 8 Ω
Side tone 500 Ω

Specifications are measured in accordance with FCC Part87 and RTCA DO-186a.
(RTCA DO-186a: Class C/E, Class 4/6)

All stated specifications are subject to change without notice or obligation.

1-2 IC-A110EURO SPECIFICATIONS

■ GENERAL

- Frequency coverage : 118.000–136.975 MHz
- Channel spacing : 25 kHz/8.33 kHz
- Type of emission : AM (6K00A3E)
- No. of memory channels : 20 channels
- Antenna connector : SO-239 (50 Ω)
- Power supply requirement : 13.75 V DC or 27.5 V DC (negative ground)
- Current drain (13.75 V DC) :

Transmit	5.0 A max
Receive	max. audio 4.0 A max
	stand-by 500 mA max
- Usable temperature range : –20°C to +55°C; –4°F to +131°F
- Dimensions : 150(W) × 50(H) × 180(D) mm;
(projections not included) 5²⁹/₃₂(W) × 1³¹/₃₂(H) × 7³/₃₂(D) in.
- Weight : 1.5 kg; 3 lb 5 oz.

■ TRANSMITTER

- Output power : 9.0 W ±1.5 dB
(at 13.75 V DC)
(+15°C to +35°C; +59°F to +95°F)
9.0 W +2 dB or –3 dB
(–20°C to +55°C; +68°F to +131°F)
- Frequency error : ±1 ppm
(0°C to +40°C; +32°F to +104°F)
- Modulation depth : More than 85 %
- Modulation compression : Linear 85 %
Maximum 95 %
- Modulation system : Last stage modulation
- Amplitude mod. distortion : Less than 10 %
- Input impedance : 600 Ω
- Audio frequency response : +2 dB to –4 dB
(From 350 Hz to 2500 Hz)
More than –25 dB at 5000 Hz
(at 25 kHz channel spacing)
More than –25 dB at 3200 Hz
(at 8.33 kHz channel spacing)
- Adjacent channel power : Less than 60 dB
(at 25 kHz channel spacing)
Less than 50 dB
(at 8.33 kHz channel spacing)
- Conducted spuri. emissions : Less than –46 dBm
(Except ±1 kHz of operating frequency)
(9 kHz to 30 MHz)
Less than –36 dBm for harmonics
(30 MHz to 1 GHz)
Less than –46 dBm for non-harmonics
(30 MHz to 1 GHz)
Less than –30 dBm for harmonics
(1 GHz to 4 GHz)
Less than –40 dBm for non-harmonics
(1 GHz to 4 GHz)
- Antenna requirements : Standard 50 Ω antenna with a VSWR < 3 : 1

■ RECEIVER

- Receive system : Double conversion super-heterodyne system
- Intermediate frequencies : 1st 38.85 MHz
2nd 450 kHz
- Sensitivity : Less than 1.8 μV
(at 12 dB SINAD)
- Squelch sensitivity : Less than 0.5 μV
(at threshold)
- Harmonics distortion : Less than 5 %
(at 30 % modulation)
Less than 10 %
(at 90 % modulation)
- Audio frequency response : +2 dB to –4 dB from 350 Hz to 3000 Hz
(at 25 kHz ch. spacing)
+2 dB to –4 dB from 350 Hz to 2500 Hz
(at 8.33 kHz ch. spacing)
- Audio noise : More than 40 dB
- Adjacent channel rejection : More than 60 dB
- Spurious response rejection : More than 70 dB
- Intermodulation response : More than 64 dB
- Blocking or desensitisation : More than 70 dB
- Spurious emissions : Less than –57 dBm
(9 kHz–1 GHz)
Less than –47 dBm
(1 GHz–4 GHz)
- Cross modulation rejection : More than 70 dB
- Receiver dynamic range : Less than 6 dB
- Audio output power :
 - Ext SP.
More than 10.0 W at 10% distortion with 8 Ω load
 - Side tone
More than 100 mW at 10% distortion with 500 Ω load

Specifications are measured in accordance with EN 300 676.

All stated specifications are subject to change without notice or obligation.

SECTION 2 INSIDE VIEWS

● MAIN UNIT (IC-A110) <TOP VIEW>

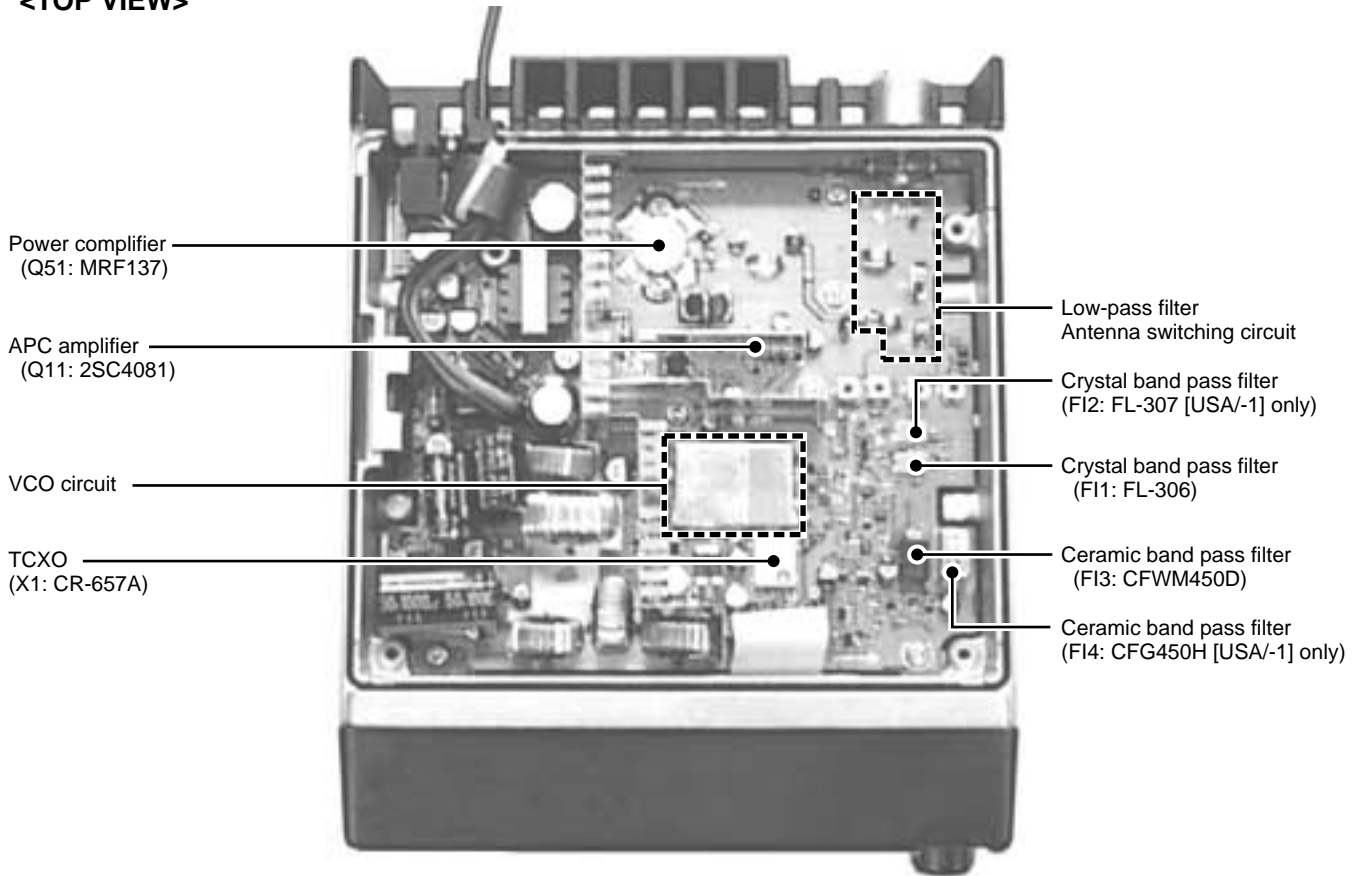

<BOTTOM VIEW>

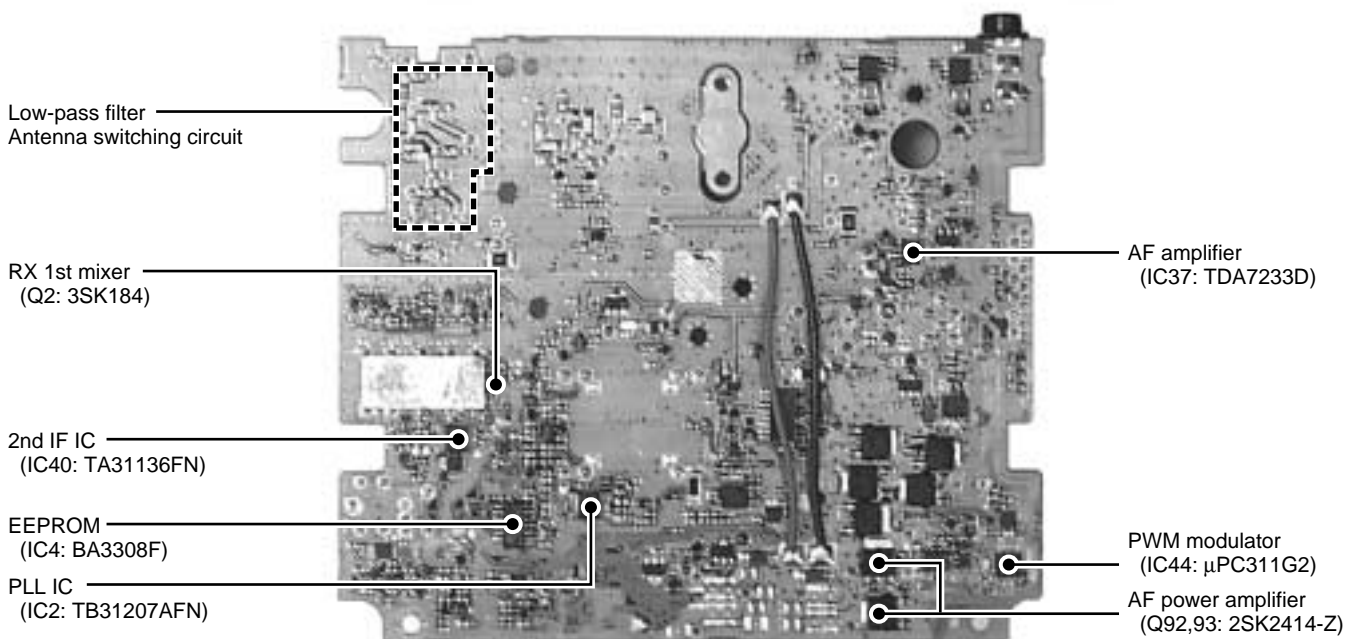

● MAIN UNIT (IC-A110EURO)
<TOP VIEW>

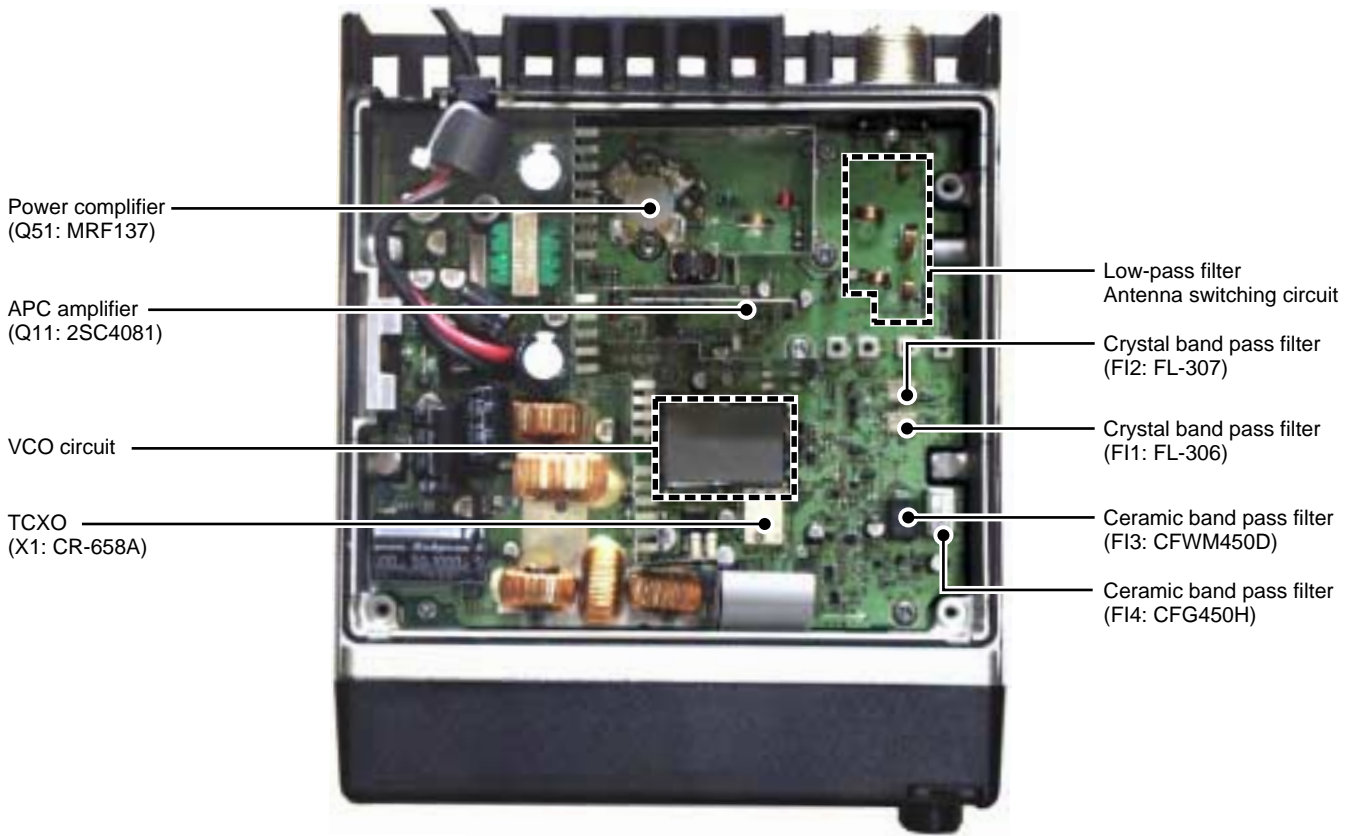

<BOTTOM VIEW>

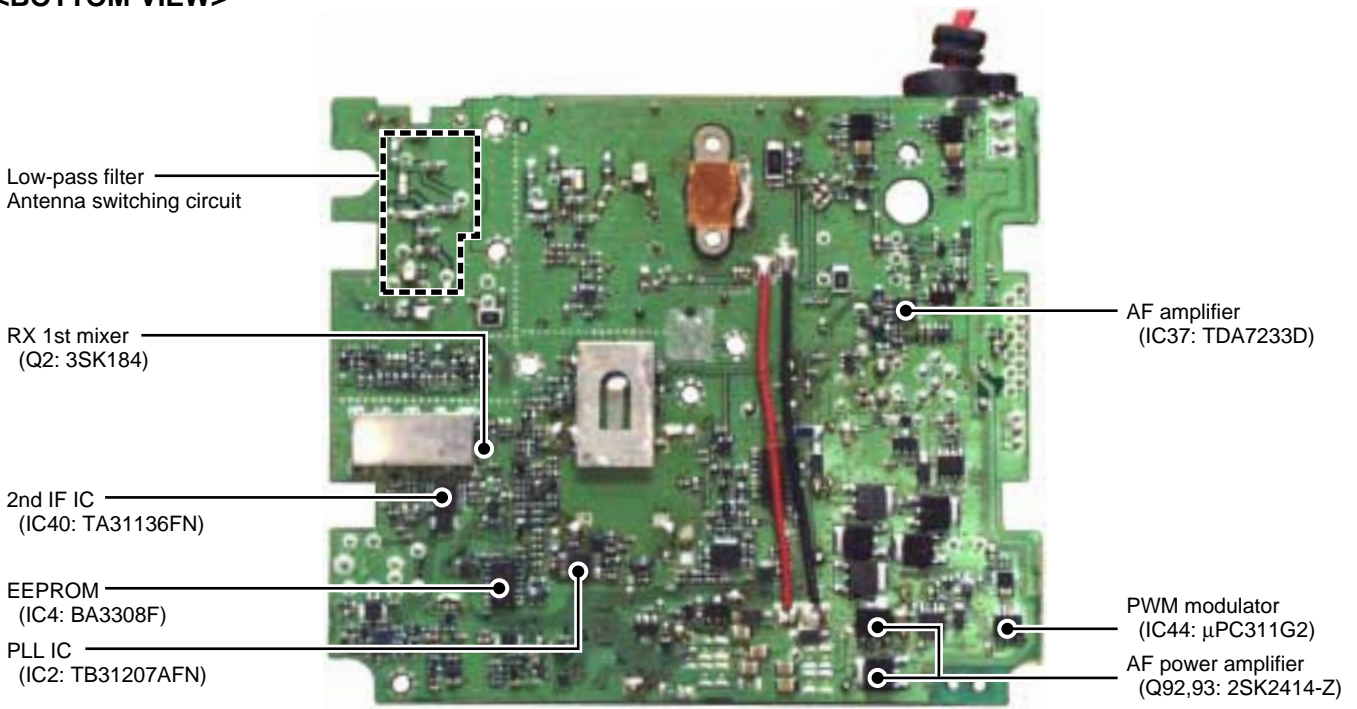

SECTION 3 CIRCUIT DESCRIPTION

3-1 RECEIVER CIRCUITS

3-1-1 ANTENNA SWITCHING CIRCUIT (MAIN UNIT)

The antenna switching circuit functions as a low-pass filter while receiving. However, its impedance becomes very high while D1 and D2 are turned ON. Thus transmit signals are blocked from entering the receiver circuits. The antenna switching circuit employs a $\lambda/4$ type diode switching system. The passed signals are then applied to the RF amplifier circuit.

Received signals are passed through the low-pass filter (L2, L3, L48, C1–C6, C330, C331). The filtered signals are applied to the $\lambda/4$ type antenna switching circuit (D1, D2).

3-1-2 RF CIRCUIT (MAIN UNIT)

The RF circuit amplifies signals within the range of frequency coverage and filters out-of-band signals.

The signals from the antenna switching circuit are amplified at the RF amplifier (Q1) after passing through the RX attenuator (D38, L52, R295), bandpass filter (L27, L8, C10, C164, C165, C21) and two-stage tunable bandpass filters (the first filter is consisted of D6, L9, C342, C405 and the second filter is consisted of D37, L49, C23, C406). The amplified signals are applied to the 1st mixer circuit (Q2, gate 1) after out-of-band signals are suppressed at the another two-stage tunable bandpass filters (D7, L10, C28, C407 and D8, L11, C31, C553).

The tunable bandpass filters (D6–D8, D37) which employ varactor diodes, track the filters and are controlled by the PLL IC (IC2) via the tune buffer amplifier (Q79) using "TUNE" signal. These diodes tune the center frequency of an RF passband for wide bandwidth receiving and good image response rejection.

3-1-3 1ST MIXER AND 1ST IF CIRCUITS (MAIN UNIT)

The 1st mixer circuit converts the received signal into a fixed frequency of the 1st IF signal with a PLL output frequency. By changing the PLL frequency, only the desired frequency will pass through a crystal filter at the next stage of the 1st mixer.

The filtered signals from the RF circuit are mixed at the 1st mixer (Q2) with a 1st LO signal coming from the VCO circuit to produce a 38.85 MHz 1st IF signal.

The 1st IF signal is applied to a pair of crystal filter [Wide mode: F11, Narrow mode: F12] to suppress out-of-band signals. The filtered 1st IF signal is applied to the IF amplifier (Q3), then applied to the 2nd mixer circuit (IC40, pin 16).

3-1-4 2ND MIXER AND 2ND IF CIRCUITS (MAIN UNIT)

The 2nd mixer circuit converts the 1st IF signal into a 2nd IF signal. A double conversion superheterodyne system (which converts receive signals twice) improves the image rejection ratio and obtains stable receiver gain.

The 1st IF signal from the IF amplifier is applied to the 2nd mixer section of the IF IC (IC2, pin 16), and is mixed with the 38.4 MHz 2nd LO signal to be converted into a 450 kHz 2nd IF signal.

A 2nd LO signal (38.4 MHz) is produced at the PLL circuit by tripling its reference frequency (12.8 MHz).

The 2nd IF signal from the 2nd mixer (IC2, pin 3) passes through a ceramic filter [Wide mode: FL3, Narrow mode: FI4] to remove unwanted heterodyned frequencies. It is then amplified at the 2nd IF amplifiers (Q4–Q6).

• RECEIVER CONSTRUCTION

118.000—136.975 MHz

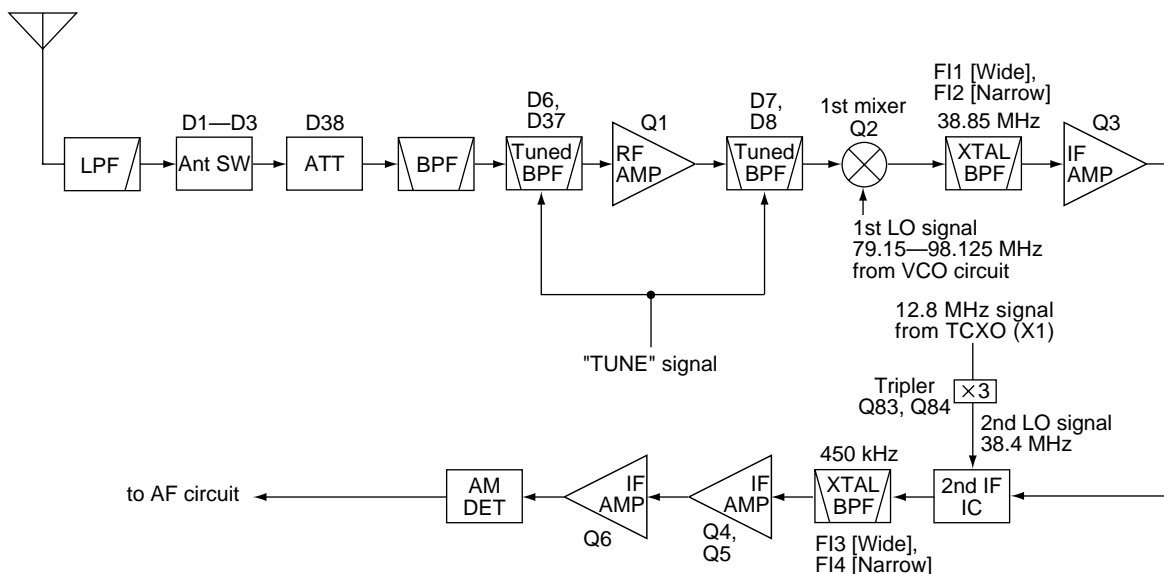

3-1-5 AM DETECTOR CIRCUIT (MAIN UNIT)

The AM detector circuit converts the 2nd IF signal into AF signals.

The amplified 2nd IF signal from the 2nd IF amplifier (Q6) is applied to the AM detector circuit (Q7). It is then detected for conversion to AF signals.

The AF signals are applied to the AF circuit.

3-1-6 AF CIRCUIT (MAIN UNIT)

The AF circuit amplifies the demodulated AF signals to drive a speaker.

The AF signals are passed through the low pass filter (IC31, pin 1), and then applied to the MOD/AF select switch (IC22, pin 7).

The AF signals are amplified at the AF amplifier (IC42, pin 3), and are then passed through the receiver mute switch (IC6) and electric-volume switch (IC13, pins 14, 15) to control AF level. The level controlled signals are then applied to the mute switch (IC30, pin 1).

While in using the internal speaker or connecting outer speaker jack, the AF signals are applied to the MOD/AF switch (IC48, pin 7) via the AF mute switch (IC28). The applied AF signals are compared at the PWM IC (IC44) with the reference signal from the triangular wave oscillator (IC45), and are then converted to the PWM wave form. The AF signals are amplified at the FET driver (IC47) and AF power amplifiers (Q92, Q93). The amplified AF signals are applied to the SP mute switch (Q100, Q101, D66) via the line filter (L62–L64, L81, C456, C457, C462, C463). The filtered AF signals are applied to the internal speaker via the [EXT SP] jack (J7).

While in connecting the head set, the AF signals are amplified at the AF power amplifier (IC37, pin 8), and then applied to the ACC connector (J6, pin 6) via the impedance converter (T1).

3-1-7 SQUELCH CIRCUIT (MAIN AND FRONT UNITS)

The squelch circuit cuts out AF signals when receiving no modulated signal. When no voice modulation is included in the signal, the squelch circuit cuts out the AF signal by comparing voice audio and noise audio components in the AF detected signals.

The 2nd IF signal from the IF IC (MAIN unit; IC40, pin 3) passes through the 450 kHz ceramic filter (Wide mode: FI3, Narrow mode: FI4) to remove out-of-band signals, and then applied to the IF amplifier.

A portion of the amplified 2nd IF signal from the IF amplifier (MAIN unit; Q4) is applied to the IF amplifier section on the IF IC (MAIN unit; IC40, pin 5). The amplified signal passes through the RSSI section, and are then applied to the squelch amplifier (MAIN unit; IC11, pin 1) as "RSSI" signal.

The amplified "RSSI" signal at IC11 is output from pin 4 as "SQLI" signal, and is then applied to the CPU (FRONT unit; IC1, pin 74). The CPU analyzes the noise condition and outputs the "AFMUT" signal via the output expander IC (FRONT unit; IC5) to switch the SP mute switch (MAIN unit; Q100, Q101), etc. When connecting the head set, "RMUTE" signal from the CPU via the output expander IC (FRONT unit; IC5) is applied to the RMUTE circuit (MAIN unit; IC6, Q80, Q81).

Even when the squelch is closed, the mute switch (IC30) opens at the moment of emitting beep tones.

3-1-8 AGC CIRCUIT (MAIN UNIT)

The AGC (Automatic Gain Control) circuit reduces signal fading and keeps the audio output level constant.

AF signal from the AM detector circuit (Q7) is amplified at AGC amplifiers (Q77, Q78). The amplified signal from Q77 is applied to the IF amplifier (Q3, Q4, Q5). The other amplified signal from Q78 is applied to the RF amplifier (Q1), and the RX attenuator (D38) via the buffer amplifier (Q73).

These amplifiers reduce the amplifier gain of IF amplifiers (Q3, Q4, Q5) and the RF amplifier (Q1) while receiving a strong signal.

• AGC CIRCUIT

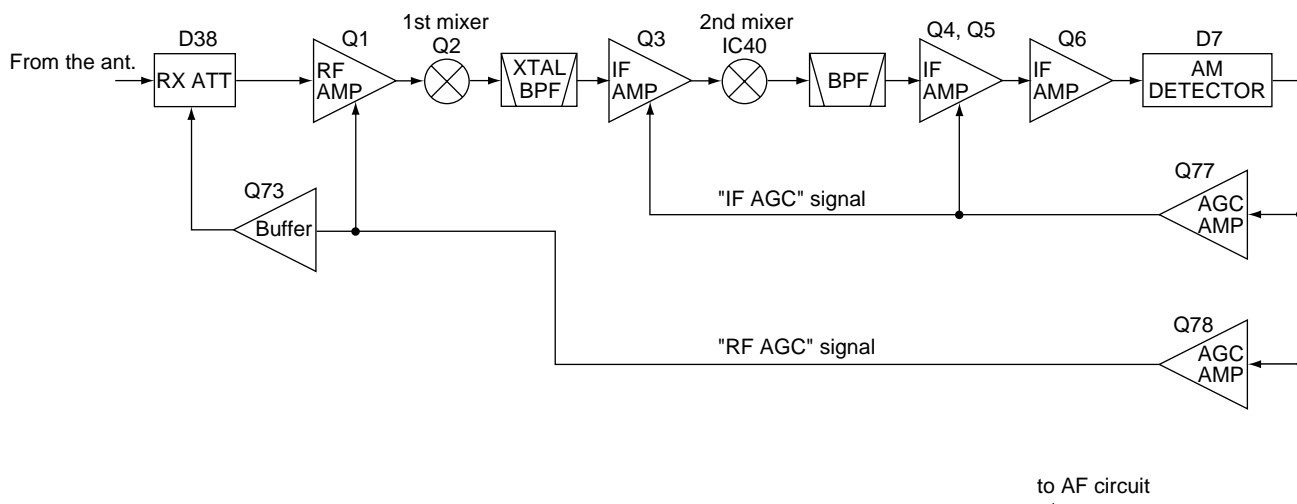

3-2 TRANSMITTER CIRCUITS

3-2-1 MICROPHONE AMPLIFIER CIRCUIT (MAIN UNIT)

The microphone amplifier circuit amplifies audio signals from the microphone, within +6 dB/octave pre-emphasis characteristics (300 Hz–3 kHz), to a level needed for the modulation circuit.

The AF signals from the microphone are applied to the IN/EXT MIC switch (IC16, pin 7) via the "MIC" signal. When using a headset, "EXTMIC" signal are applied to the external switch (IC16, pin 6) via R336 to adjust the external microphone level. The output signal from IC16 (pin 1) are applied to the ALC amplifier (IC4, pin 9) via R110 to adjust the microphone sensitivity.

The output signal from IC4 (pin 7) are amplified at the AF amplifier (IC5), and then applied to the MOD/AF switch via the high-pass filter (IC51) and low-pass filter (IC19) to filter out RF components. The filtered signals are applied to the modulation circuit.

3-2-2 MODULATION CIRCUIT (MAIN UNIT)

The modulation circuit modulates the VCO oscillating signal (RF signal) using the microphone AF signal.

The audio signals are passed through the MOD/AF switch (IC48, pin 6) via the modulation depth adjustment pot R121. The signals are converted to the PWM (Pulse-Width-Modulation) wave form at the PWM IC (IC44, pin 3), and power amplified at the FET driver (IC47, pin 5) and power MOS FET (Q92, Q93). The power-amplified signals are passed through the line filter (L62–L64, L81, C456, C457, C462, C463, C468), and then applied to the drain of power amplifier (Q51) for the last stage modulation.

3-2-3 DRIVE/POWER AMPLIFIER CIRCUITS (MAIN UNIT)

The amplifier circuit amplifies the VCO oscillating signal to the output power level.

The signal from the buffer amplifiers (Q14, Q15) is passed through the TX/RX switch (D11), and is amplified at the pre-amplifier (Q42), pre-drivers (Q20, Q21) and the power amplifier (Q51) to obtain 9 W of RF power.

The amplified signal is passed through the antenna switching circuit (D3) and low-pass filter, and is then applied to the antenna connector.

3-2-4 APC CIRCUIT (MAIN UNIT)

The APC (Automatic Power Control) circuit protects the drive and power amplifiers from mismatched output loads.

The APC detector circuit (D4, D5) detects forward and reflected signals respectively. The combined voltage is at a minimum level when the antenna is matched at 50 Ω and is increased when it is mismatched.

The detected voltage is applied to one of the APC controller inputs (IC50, pin 3) and a power setting voltage is applied to the other input (pin 1). When the antenna impedance is mismatched, the detected voltage exceeds the reference voltage. Thus the bias voltage of the pre-drivers is decreased.

• APC CONTROL CIRCUIT

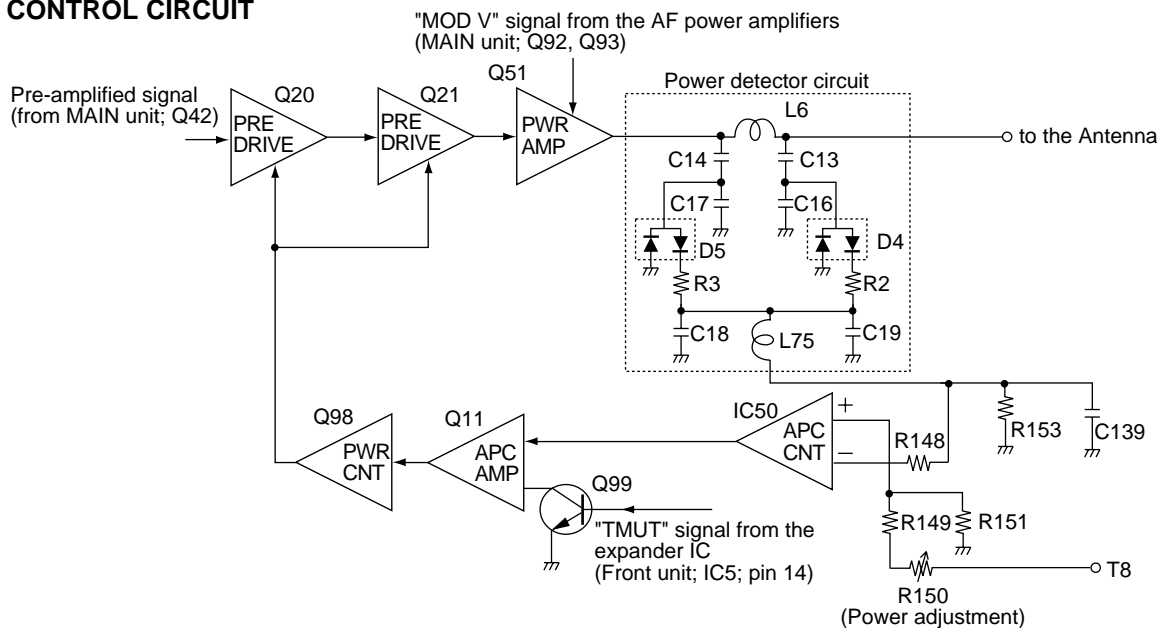

3-3 PLL CIRCUIT

3-3-1 GENERAL (MAIN UNIT)

A PLL circuit provides stable oscillation of the transmit frequency and receive 1st LO frequency. The PLL output compares the phase of the divided VCO frequency to the reference frequency. The PLL output frequency is controlled by the divided ratio (N-data) of a programmable divider.

The PLL circuit contains of the TX-VCO and RX-VCO circuits. The oscillated signals are applied to the buffer amplifiers (Q43, Q12) then applied to the PLL IC (IC2, pin 8). IC2 is a dual PLL IC which controls VCO circuits for TX and RX.

The PLL circuit, using a one chip PLL IC (IC2), directly generates the transmit frequency and receive 1st IF frequency with VCOs. The PLL sets the divided ratio based on serial data from the CPU on the FRONT unit and compares the phases of VCO signals with the reference oscillator frequency. The PLL IC detects the out-of-step phase and output from pin 9 for TX and RX, respectively. The reference frequency (12.8 MHz) is oscillated at X1.

3-3-2 TX LOOP (MAIN UNIT)

The generated signal at the TX-VCO (Q44, D64) enters the PLL IC (IC2, pin 8), and is divided at the programmable divider section and is then applied to the phase detector section.

The phase detector compares the input signal with a reference frequency, and then outputs the out-of-phase signal (pulse-type signal) from pin 9.

The pulse-type signal is converted into DC voltage (lock voltage) at the loop filter (R61, R62, C59, C60), and then applied to the varactor diode (D64) of the TX-VCO to stabilize the oscillated frequency.

3-3-3 RX LOOP (MAIN UNIT)

The generated signal at the RX-VCO (Q59, D65) enters the PLL IC (IC2, pin 8), and is divided at the programmable divider section. The divided signal is then applied to the phase detector section.

The phase detector compares the input signal with a reference frequency, and then outputs the out-of-phase signal (pulse-type signal) from pin 9.

The pulse-type signal is converted into DC voltage (lock voltage) at the loop filter (R61, R62, C59, C60), and then applied to the varactor diode (D65) of the RX-VCO to stabilize the oscillated frequency. The lock voltage is also used for the receiver circuit for the bandpass filter center frequency. The lock voltage from the PLL IC (IC2, pin 9) passes through the low-pass filter, and is applied to the tune buffer amplifier (Q79). The amplified signal is applied to the RF bandpass filters (D7, D8 and D6, D37) via the tune adjustment pot (R59).

3-3-4 VCO CIRCUIT (MAIN UNIT)

The VCO outputs from Q44 (TX) and Q59 (RX) are buffer amplified at Q43, and are applied to the buffer amplifiers (Q14, Q15). The amplified signal is applied to the T/R switch (D10, D11). The receive LO signal is applied to the 1st mixer circuit (Q2), and the transmit signal is applied to the pre-amplifier (Q42).

A portion of the VCO signal is amplified at the buffer amplifier (Q12), and then fed back to the PLL IC (IC2, pin 8).

• PLL CIRCUIT

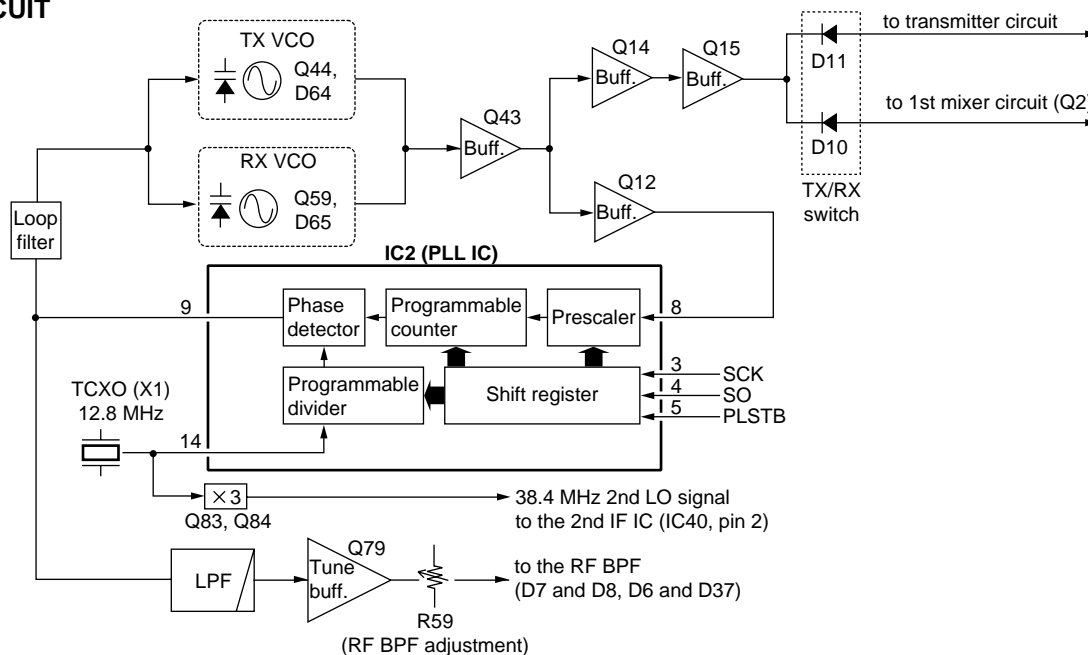

3-4 POWER SUPPLY CIRCUITS VOLTAGE LINES (MAIN UNIT)

LINE	DESCRIPTION
VCC	The voltage from the external DC power connector which is controlled by the power switch ([VOL] control).
8V	Common 8 V converted from the VCC line by the +8 V regulator circuit (IC29). The output voltage is applied to the +5 V regulator circuit (IC7), the ripple filter (Q16), and etc.
+5V	Common 5 V converted from the 8V line by the +5V regulator (IC7) and +5V current amplifier (Q22, Q23, D15) circuits. The output voltage is applied to the electric volume IC (IC13), buffer amplifiers (Q68, Q69), and etc.
CPU5V	Common 5 V converted from the VCC line by +8 V regulator (Q82, D35) and +5 V regulator circuits (IC26). The output 5 V voltage is applied to the CPU (FRONT unit; IC1).
T8	8 V for transmitter circuits regulated by the +8 V regulator circuit (IC29).
R8	8 V for receiver circuits regulated by the +8 V regulator circuit (IC29).

3-5 PORT ALLOCATIONS 3-5-1 OUTPUT EXPANDER IC (FRONT UNIT: IC5)

Pin number	Port name	Description															
4, 5	LED1, LED2	Outputs backlight control signals.															
		<table border="1"> <thead> <tr> <th>LED1</th> <th>LED2</th> <th>Backlight condition</th> </tr> </thead> <tbody> <tr> <td>Low</td> <td>Low</td> <td>Light OFF</td> </tr> <tr> <td>High</td> <td>Low</td> <td>No establishment</td> </tr> <tr> <td>Low</td> <td>High</td> <td>Light ON, Dimmer ON</td> </tr> <tr> <td>High</td> <td>High</td> <td>Light ON, Dimmer OFF</td> </tr> </tbody> </table>	LED1	LED2	Backlight condition	Low	Low	Light OFF	High	Low	No establishment	Low	High	Light ON, Dimmer ON	High	High	Light ON, Dimmer OFF
		LED1	LED2	Backlight condition													
		Low	Low	Light OFF													
		High	Low	No establishment													
Low	High	Light ON, Dimmer ON															
High	High	Light ON, Dimmer OFF															
6	TRC	Outputs control signal to the MOD/AF switch (MAIN unit: IC48, pin 5) and etc. High: While transmitting.															
7	R/T	Outputs control signal to the TX/RX switch (MAIN unit: Q58, pin 1) for VCO. Low: While transmitting.															
11	SMUT	Outputs AF mute switch (MAIN unit: IC30, Q86, Q75, Q74, D43) control signal. Low: While squelched.															
12	AFMUT	Outputs control signal to the mute switch (MAIN unit; Q100, Q101, D66) for speaker amplifier, and etc. Low: While the speaker output is muted.															
13	RMUT	Outputs RMUTE switch (IC6) control signal. Low: While squelched.															
14	TMUT	Outputs T8 regulator control signal. Low: When TX is muted.															

3-5-2 CPU (FRONT UNIT; IC1)

Pin number	Port name	Description
1, 2, 3, 5, 8, 12	KR4	Input ports for the key matrix.
9	RESET	Input port for the CPU reset signal.
10	PSWC	Outputs control signal for the power supply circuit. High: Power is ON.
11	BEEP	Outputs beep audio signals.
13	ECK	Outputs clock signal to the EEPROM (FRONT unit; IC4, pin 6).
14	ESO	Outputs data signal to the EEPROM (FRONT unit; IC4, pin 5).
15	ECS	Outputs chip select signal to the EEPROM (FRONT unit; IC4, pin 1).
16, 17	DLA, DLB	Input port for the [DIAL] control signal.
18	OE	Outputs control signal to the expander IC (FRONT unit; IC5, pin 15).
19	EXSTB	Outputs strobe signals to the expander IC (FRONT unit; IC5, pin 1).
20	VCS	Outputs chip select signal to the electric volume (MAIN unit; IC13). Low: While volume is controlled.
21	SCK	Outputs serial clock to the PLL IC (MAIN unit; IC2, pin 3), the expander IC (FRONT unit; IC5, pin 3) and the electric volume (MAIN unit; IC13, pin 8).
22	ESI	Input port for the data signal from the EEPROM (FRONT unit; IC4, pin 2).
23	SO	Outputs serial data to the PLL IC (MAIN unit; IC2, pin 4), the expander IC (FRONT unit; IC5, pin 2) and the electric volume (MAIN unit; IC13, pin 9).
24	PLSTB	Outputs strobe signals to the PLL IC (MAIN unit; IC2, pin 5).
25	FISW	Outputs 2nd IF filter's select signal. High: While wide is selected.
69	UNLK	Input port for the unlock signal from the PLL IC (MAIN unit; IC2, pin 11). Low: PLL is unlocked.
70	CLIN	Input port for the cloning signal.
71	CLO	Output port for the cloning signal.
72	PSW	Input port for the POWER switch. Low: While POWER switch is pushed
74	SQLI	Input port for the squelch signal.

Pin number	Port name	Description
76	HANG	Input port for the microphone hanger detection signal. Low: Microphone on hook.
77	PTT	Input port for the PTT switch. High: While PTT switch is pushed.
78-80	KR1-KR2	Input ports for the key matrix.

SECTION 4 ADJUSTMENT PROCEDURES

4-1 PREPARATION

- Some versions may need the optional CS-A110 CLONING SOFTWARE and OPC-478, OPC-592 CLONING CABLE for setting the adjustment frequency.
- All adjustments must be performed on the [Wide] mode.

■ REQUIRED TEST EQUIPMENT

EQUIPMENT	GRADE AND RANGE	EQUIPMENT	GRADE AND RANGE
DC power supply	Output voltage : 13.75 V DC Current capacity : 10 A or more	DC voltmeter	Input impedance : 50 kΩ/V DC or better
RF power meter (terminated type)	Measuring range : 1–50 W Frequency range : 50–300 MHz Impedance : 50 Ω SWR : Less than 1.2 : 1	Digital multimeter	Input impedance : 10 MΩ/V DC or better
		Audio generator	Frequency range : 300–3000 Hz Measuring range : 1–500 mV
Frequency counter	Frequency range : 0.1–300 MHz Frequency accuracy : ±1 ppm or better Sensitivity : 100 mV or better	Standard signal generator (SSG)	Frequency range : 0.1–300 MHz Output level : 0.1 μV–32 mV (–127 to –17 dBm)
		AC millivoltmeter	Measuring range : 10 mV–10 V
Modulation analyzer	Frequency range : DC–300 MHz Measuring range : 0 to 100 %	Attenuator	Power attenuation : 40 or 50 dB Capacity : 50 W or more
Distortion meter	Frequency range : 1 kHz±10 % Measuring range : 1 to 100 %	Terminator	Impedance : 50 Ω Capacity : 50 W or more
External speaker	Impedance : 8 Ω		

■ VFO CHANNEL ID LIST

- Channel spacing: 8.33/25 kHz [USA/USA-1]

Operating Freq. (MHz)	Channel spacing (kHz)	Channel ID (Displayed Freq.)
118.0000	25	118.000
118.0000	8.33	118.005
118.0083	8.33	118.010
118.0167	8.33	118.015
118.0250	25	118.020
118.0250	8.33	118.030
118.0333	8.33	118.035
118.0417	8.33	118.040
118.0500	25	118.050
118.0500	8.33	118.055
118.0583	8.33	118.060
118.0667	8.33	118.065
118.0750	25	118.070
118.0750	8.33	118.080
118.0833	8.33	118.085
118.0917	8.33	118.090
118.1000	25	118.100
118.1000	8.33	118.105
etc		

- Channel spacing: 25 kHz [GEN/GEN-1]

Operating Freq. (MHz)	Channel spacing (kHz)	Channel ID (Displayed Freq.)
118.0000	25	118.000
118.0250	25	118.025
118.0500	25	118.050
118.0750	25	118.075
118.1000	25	118.100
etc		

■ CONNECTION

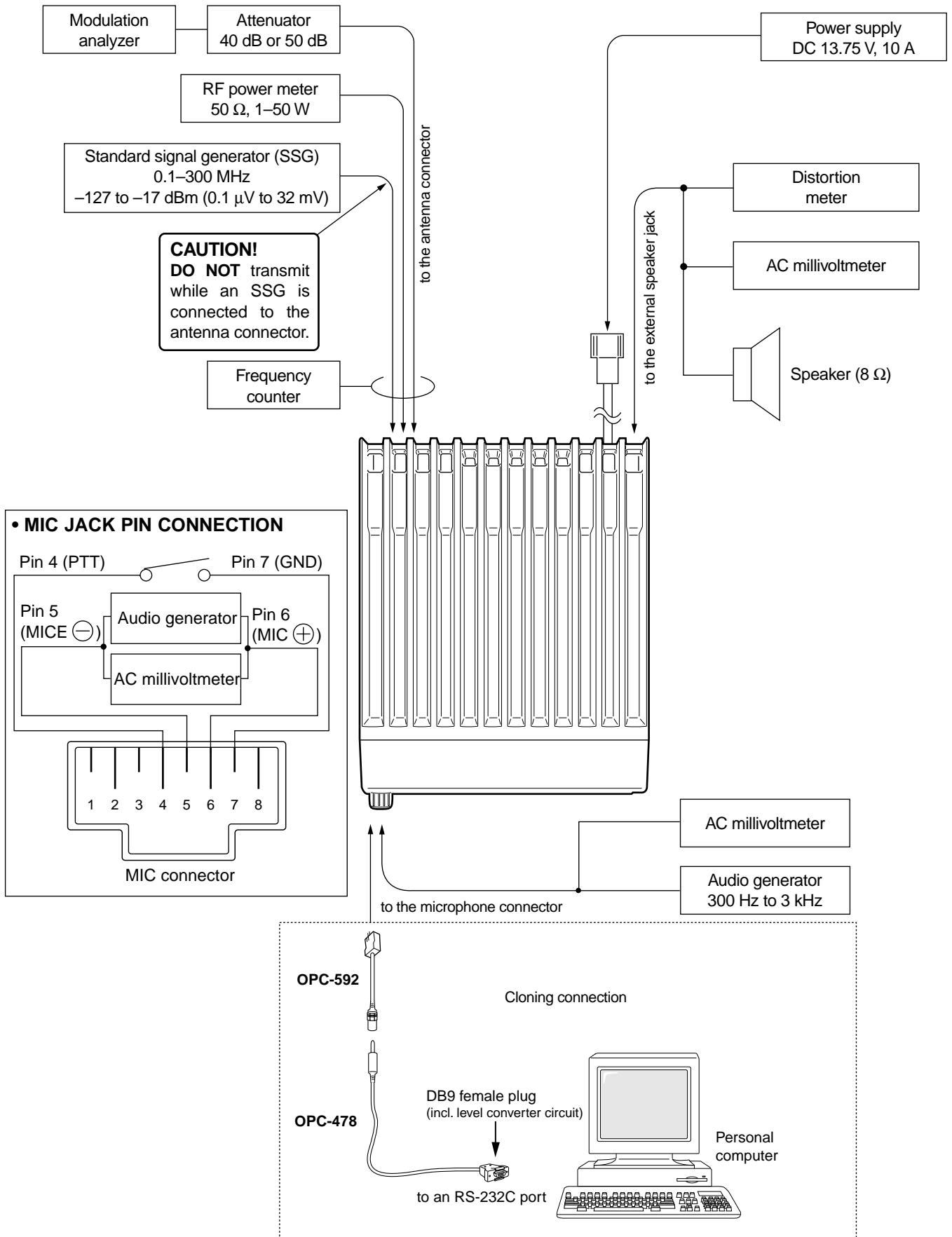

4-2 PLL ADJUSTMENT

ADJUSTMENT	ADJUSTMENT CONDITION	MEASUREMENT		VALUE	ADJUSTMENT POINT	
		UNIT	LOCATION		UNIT	ADJUST
Vdd VOLTAGE	1 • Operating frequency : 118.000 MHz • Receiving	MAIN	Connect a digital multi-meter to drain terminal of Q51.	13.5 V	MAIN	R392
PLL LOCK VOLTAGE	1 • Operating frequency : 118.000 MHz • Receiving	MAIN	Connect a digital multi-meter to the check point CP2.	0.5 V 0.5 V [A110] 0.3 V [A110EURO]	MAIN	L41
	2 • Transmitting					L40
TUNE VOLTAGE	1 • Operating frequency : 118.000 MHz • Receiving	MAIN	Connect a digital multi-meter to the check point CP1.	0.7 V	MAIN	R59
REFERENCE FREQUENCY	1 • Operating frequency : 136.950 MHz • Connect an RF power meter or a 50 Ω dummy load to the antenna connector. • Transmitting	Rear panel	Loosely couple the frequency counter to the antenna connector.	136.9500 MHz	MAIN	X1

4-3 TRANSMITTER ADJUSTMENT

ADJUSTMENT	ADJUSTMENT CONDITION	MEASUREMENT		VALUE	ADJUSTMENT POINT	
		UNIT	LOCATION		UNIT	ADJUST
OUTPUT POWER	1 • Operating frequency : 127.000 MHz • No audio applied to the [MIC] jack. • Transmitting	Rear panel	Connect an RF power meter to the antenna connector.	9.0 W	MAIN	R150
MODULATION DEPTH	1 • Operating frequency : 127.000 MHz • Connect an audio generator to the [MIC] jack and set as : 1 kHz/10 mVrms • Set a modulation analyzer as : HPF : OFF LPF : OFF De-emphasis : OFF Detector : (P-P)/2 • Pre-set R110 and R121 on the MAIN unit to the center position. • Transmitting	Rear panel	Connect a modulation analyzer to the antenna connector through an attenuator.	90 % 30 %	MAIN	R121
	2 • Set an audio generator as : 1 kHz/1 mVrms • Transmitting					R110
HEAD SET MODULATION	1 • Operating frequency : 127.000 MHz • Connect an audio generator to the [EXT MIC] jack and set as : 1 kHz/1 mVrms • Transmitting	Rear panel	Connect a modulation analyzer to the antenna connector through an attenuator.	30 %	MAIN	R336

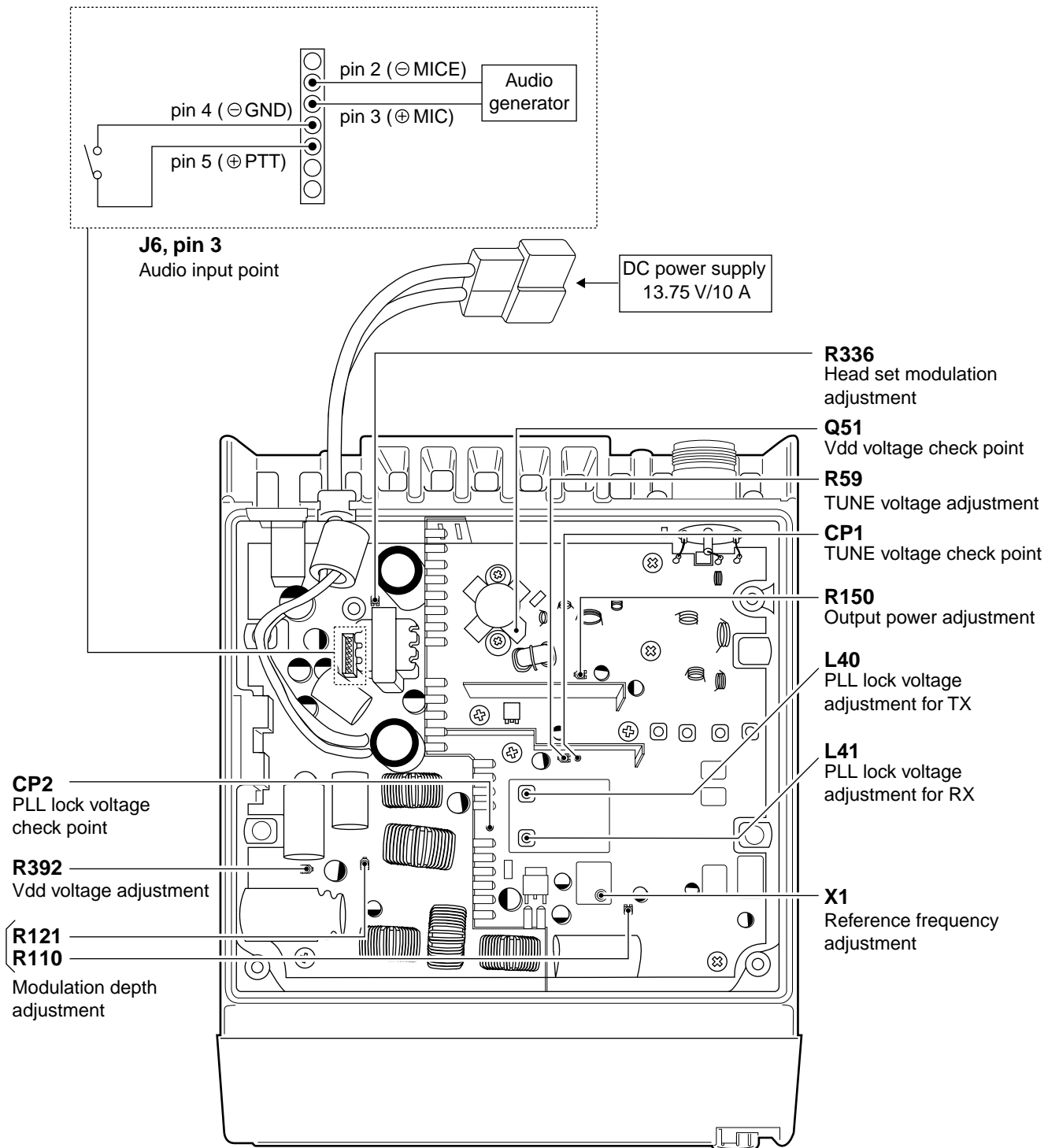

4-4 RECEIVER ADJUSTMENT

“SQUELCH ADJUSTMENT” must be performed at “SQUELCH ADJUSTMENT MODE”.

ADJUSTMENT	ADJUSTMENT CONDITION	MEASUREMENT		VALUE	ADJUSTMENT POINT		
		UNIT	LOCATION		UNIT	ADJUST	
RX SENSITIVITY	1 <ul style="list-style-type: none"> Operating frequency : 118.000 MHz Pre-set L9, L10, L11, L49 on the MAIN unit to max. CCW. Connect an SSG to the antenna connector and set an SSG as : <ul style="list-style-type: none"> Level : 1.0 μV* (-107 dBm) Modulation : \pm 1 kHz Mod. depth : 30 % Receiving 	Rear panel	Connect an AC millivoltmeter and distortion meter with 8 Ω load to the external [SP] jack.	Maximum AF output level	MAIN	L9, L10, L11, L49	
	2 <ul style="list-style-type: none"> Operating frequency : 136.975 MHz Receiving 					Maximum AF output level	R59
SQUELCH	1 <ul style="list-style-type: none"> Enter the “Squelch adjustment mode”. <ol style="list-style-type: none"> Program 118.000 MHz into memory channel. Turn power OFF. While pushing [SQL], [TS], [SCAN], turn power ON. Connect an SSG to the antenna connector and set an SSG as : <ul style="list-style-type: none"> Level : <ul style="list-style-type: none"> [A110] 0.18 μV* (-122 dBm) [A110EURO] 0.25 μV* (-119 dBm) Modulation : OFF Receiving 	Front panel	Display	<ul style="list-style-type: none"> Verify the display indicates “sqADJ02”. NOTE: If the display shows other, turn [MAIN DIAL] to select “sqADJ02”. Push the [SCAN] key to set the threshold level. 			
	2 <ul style="list-style-type: none"> Set an SSG as : <ul style="list-style-type: none"> Level : 5.6 μV* (-92 dBm) Modulation : OFF 						<ul style="list-style-type: none"> Verify the display indicates “sqADJ25”. Push the [SCAN] key to set the tight level.
	3 <ul style="list-style-type: none"> Turn power OFF to cancell the “Squelch adjustment mode”. <p>NOTE: Until turn power OFF, “Squelch adjustment mode” is not cancelled, and once pushing the [SCAN] key, display indicates “sqADJ02” (threshold level adjustment) or “sqADJ25” (tight level adjustment) repeatedly</p>						

*This output level of the standard signal generator (SSG) is indicated as SSG's open circuit.

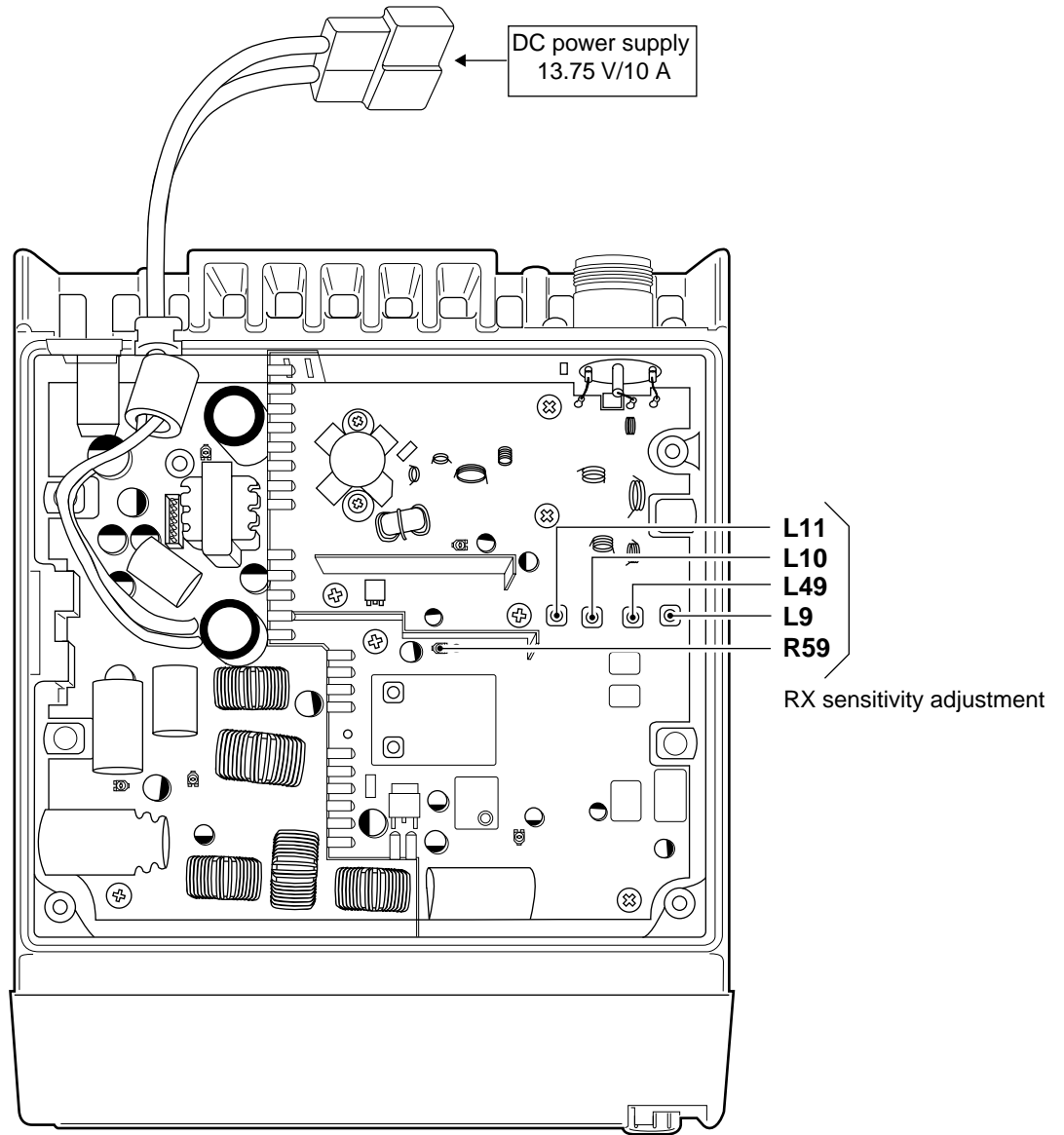

SECTION 5 PARTS LIST

[FRONT UNIT]

REF NO.	ORDER NO.	DESCRIPTION		
IC1	1140008780	S.IC	HD6433823A19D	Ⓒ
	1140009830	S.IC	HD6433823A80D	Ⓐ
IC2	1130009110	S.IC	S-80942ANMP-DD6-T2	
IC3	1130007110	S.IC	TC7W04FU (TE12L)	
IC4	1190001600	S.IC	X25170S8I-2.5	
IC5	1130007570	S.IC	BU4094BCFV-E2	
Q1	1590000440	S.TRANSISTOR	DTA143ZUA T106	
Q2	1510000880	S.TRANSISTOR	2SA1622-6-TL	
Q3	1530003280	S.TRANSISTOR	2SC4211-6-TL	
Q4	1590001980	S.TRANSISTOR	XP4315 (TX)	
Q5	1590000440	S.TRANSISTOR	DTA143ZUA T106	
Q6	1590000680	S.TRANSISTOR	DTC114EUA T106	
Q7	1590000680	S.TRANSISTOR	DTC114EUA T106	
D5	1790001280	S.DIODE	MA111 (TX)	
D6	1750000130	S.DIODE	DA204U T107	
X1	6060000770	S.CERAMIC	EFOP3684E5	
L1	6200003960	S.COIL	MLF1608A 1R0K-T	Ⓒ
	6910011690	S.COIL	ACB1608M-600-T	Ⓐ
L2	6200003540	S.COIL	MLF1608D R22K-T	Ⓒ
	6910011690	S.COIL	ACB1608M-600-T	Ⓐ
L3	6910011690	S.COIL	ACB1608M-600-T	Ⓐ only
L4	6910011690	S.COIL	ACB1608M-600-T	Ⓐ only
L5	6910011690	S.COIL	ACB1608M-600-T	Ⓐ only
L6	6910011690	S.COIL	ACB1608M-600-T	Ⓐ only
L7	6910011690	S.COIL	ACB1608M-600-T	Ⓐ only
L8	6910011690	S.COIL	ACB1608M-600-T	Ⓐ only
R1	7030003800	S.RESISTOR	ERJ3GEYJ 105 V (1 MΩ)	
R2	7030003680	S.RESISTOR	ERJ3GEYJ 104 V (100 kΩ)	
R3	7030003680	S.RESISTOR	ERJ3GEYJ 104 V (100 kΩ)	
R4	7030003580	S.RESISTOR	ERJ3GEYJ 153 V (15 kΩ)	
R5	7030003580	S.RESISTOR	ERJ3GEYJ 153 V (15 kΩ)	
R6	7030003580	S.RESISTOR	ERJ3GEYJ 153 V (15 kΩ)	
R7	7030003580	S.RESISTOR	ERJ3GEYJ 153 V (15 kΩ)	
R8	7030003560	S.RESISTOR	ERJ3GEYJ 103 V (10 kΩ)	
R9	7030003680	S.RESISTOR	ERJ3GEYJ 104 V (100 kΩ)	
R10	7030003680	S.RESISTOR	ERJ3GEYJ 104 V (100 kΩ)	
R11	7030003370	S.RESISTOR	ERJ3GEYJ 271 V (270 Ω)	
R12	7030003350	S.RESISTOR	ERJ3GEYJ 181 V (180 Ω)	
R13	7030003350	S.RESISTOR	ERJ3GEYJ 181 V (180 Ω)	
R14	7030003640	S.RESISTOR	ERJ3GEYJ 473 V (47 kΩ)	
R15	7030003590	S.RESISTOR	ERJ3GEYJ 183 V (18 kΩ)	
R16	7030003540	S.RESISTOR	ERJ3GEYJ 682 V (6.8 kΩ)	
R17	7030003620	S.RESISTOR	ERJ3GEYJ 333 V (33 kΩ)	
R18	7030003680	S.RESISTOR	ERJ3GEYJ 104 V (100 kΩ)	
R19	7030003680	S.RESISTOR	ERJ3GEYJ 104 V (100 kΩ)	
R20	7030003680	S.RESISTOR	ERJ3GEYJ 104 V (100 kΩ)	
R21	7030003680	S.RESISTOR	ERJ3GEYJ 104 V (100 kΩ)	
R22	7030003680	S.RESISTOR	ERJ3GEYJ 104 V (100 kΩ)	
R23	7030003680	S.RESISTOR	ERJ3GEYJ 104 V (100 kΩ)	
R24	7030003680	S.RESISTOR	ERJ3GEYJ 104 V (100 kΩ)	
R26	7030003680	S.RESISTOR	ERJ3GEYJ 104 V (100 kΩ)	
R27	7030003680	S.RESISTOR	ERJ3GEYJ 104 V (100 kΩ)	
R28	7030003440	S.RESISTOR	ERJ3GEYJ 102 V (1 kΩ)	
R29	7030003680	S.RESISTOR	ERJ3GEYJ 104 V (100 kΩ)	
R30	7030003560	S.RESISTOR	ERJ3GEYJ 103 V (10 kΩ)	
R31	7030003560	S.RESISTOR	ERJ3GEYJ 103 V (10 kΩ)	
R32	7030003560	S.RESISTOR	ERJ3GEYJ 103 V (10 kΩ)	
R33	7030003560	S.RESISTOR	ERJ3GEYJ 103 V (10 kΩ)	
R34	7030003500	S.RESISTOR	ERJ3GEYJ 332 V (3.3 kΩ)	
R36	7030003600	S.RESISTOR	ERJ3GEYJ 223 V (22 kΩ)	
R37	7030003680	S.RESISTOR	ERJ3GEYJ 104 V (100 kΩ)	
R38	7030003680	S.RESISTOR	ERJ3GEYJ 104 V (100 kΩ)	
R41	7030003610	S.RESISTOR	ERJ3GEYJ 273 V (27 kΩ)	
R42	7030003610	S.RESISTOR	ERJ3GEYJ 273 V (27 kΩ)	
R43	7030003580	S.RESISTOR	ERJ3GEYJ 153 V (15 kΩ)	
R44	7030003580	S.RESISTOR	ERJ3GEYJ 153 V (15 kΩ)	

[FRONT UNIT]

REF NO.	ORDER NO.	DESCRIPTION		
R45	7030003580	S.RESISTOR	ERJ3GEYJ 153 V (15 kΩ)	
R46	7030003610	S.RESISTOR	ERJ3GEYJ 273 V (27 kΩ)	
R47	7030003580	S.RESISTOR	ERJ3GEYJ 153 V (15 kΩ)	
C1	4030006860	S.CERAMIC	C1608 JB 1H 102K-T-A	
C2	4030006860	S.CERAMIC	C1608 JB 1H 102K-T-A	Ⓒ only
C3	4030007090	S.CERAMIC	C1608 CH 1H 470J-T-A	
C4	4030007090	S.CERAMIC	C1608 CH 1H 470J-T-A	Ⓒ only
C5	4030006860	S.CERAMIC	C1608 JB 1H 102K-T-A	
C6	4030007090	S.CERAMIC	C1608 CH 1H 470J-T-A	Ⓒ only
C7	4030006850	S.CERAMIC	C1608 JB 1H 471K-T-A	
C8	4030006850	S.CERAMIC	C1608 JB 1H 471K-T-A	
C9	4030008560	S.CERAMIC	C1608 CH 1H 300J-T-A	
C10	4030008560	S.CERAMIC	C1608 CH 1H 300J-T-A	
C11	4030008890	S.CERAMIC	C1608 JB 1C 273K-T-A	
C12	4030011600	S.CERAMIC	C1608 JB 1C 104KT-N	
C13	4030011600	S.CERAMIC	C1608 JB 1C 104KT-N	
C14	4030011600	S.CERAMIC	C1608 JB 1C 104KT-N	
C15	4030007090	S.CERAMIC	C1608 CH 1H 470J-T-A	
C16	4030011600	S.CERAMIC	C1608 JB 1C 104KT-N	
C17	4030011600	S.CERAMIC	C1608 JB 1C 104KT-N	
C18	4030006860	S.CERAMIC	C1608 JB 1H 102K-T-A	
C19	4030006860	S.CERAMIC	C1608 JB 1H 102K-T-A	
C20	4030011600	S.CERAMIC	C1608 JB 1C 104KT-N	
C21	4030006860	S.CERAMIC	C1608 JB 1H 102K-T-A	
C22	4030011600	S.CERAMIC	C1608 JB 1C 104KT-N	
C23	4550006480	S.TANTALUM	TEMSVA 1C 475M-8L	
C24	4030011600	S.CERAMIC	C1608 JB 1C 104KT-N	
C25	4030011600	S.CERAMIC	C1608 JB 1C 104KT-N	
C26	4030011600	S.CERAMIC	C1608 JB 1C 104KT-N	
C27	4550006250	S.TANTALUM	TEMSVA 1A 106M-8L	
C28	4030006860	S.CERAMIC	C1608 JB 1H 102K-T-A	
C29	4030006860	S.CERAMIC	C1608 JB 1H 102K-T-A	
C30	4030006890	S.CERAMIC	C1608 JF 1H 103Z-T-A	Ⓐ
	4030007090	S.CERAMIC	C1608 CH 1H 470J-T-A	Ⓒ
C31	4030006860	S.CERAMIC	C1608 JB 1H 102K-T-A	
C32	4030006860	S.CERAMIC	C1608 JB 1H 102K-T-A	
C33	4030006860	S.CERAMIC	C1608 JB 1H 102K-T-A	
C34	4030006860	S.CERAMIC	C1608 JB 1H 102K-T-A	
C35	4030006860	S.CERAMIC	C1608 JB 1H 102K-T-A	
C36	4030006860	S.CERAMIC	C1608 JB 1H 102K-T-A	
C37	4030007090	S.CERAMIC	C1608 CH 1H 470J-T-A	Ⓐ only
C38	4030006860	S.CERAMIC	C1608 JB 1H 102K-T-A	Ⓐ only
J1	6510020510	S.CONNECTOR	FH12-40S-0.5SV	
J2	6450001470	CONNECTOR	95003-2881	
DS1	5030001740	LCD	HLC7453-012400	
DS2	5040002030	S.LED	CL-170Y-CD-T	
DS3	5040002030	S.LED	CL-170Y-CD-T	
DS4	5040002030	S.LED	CL-170Y-CD-T	
DS5	5040002030	S.LED	CL-170Y-CD-T	
DS6	5040002030	S.LED	CL-170Y-CD-T	
DS7	5040002030	S.LED	CL-170Y-CD-T	
S1	2250000420	ENCODER	EVQB2CFC620B	
SP1	2510000880	SPEAKER	SME-45W	
W1	7120000470	JUMPER	ERDS2T0	
W2	7120000470	JUMPER	ERDS2T0	
W3	7030003860	S.JUMPER	ERJ3GE JPW V	
W4	7030003860	S.JUMPER	ERJ3GE JPW V	
W6	8900007680	CABLE	OPC-741 (N:40 L:55)	
EP1	0910051554	PCB	B 5319D	Ⓒ
	0910054020	PCB	B 5674	Ⓐ
EP2	8930037960	LCD CONTACT	SRCN-1705 ZSS	

Ⓐ: [A110EURO], Ⓑ: [USA-1] and [A110EURO], Ⓒ: [A110],
 Ⓓ: [GEN/-1] and [AUS]

S.=Surface mount

[MAIN UNIT]

REF NO.	ORDER NO.		DESCRIPTION	
IC2	1130008830	S.IC	TB31207AFN (EL)	
IC4	1110003670	S.IC	BA3308F-T1	
IC5	1110002750	S.IC	TA75S01F (TE85R)	
IC6	1130004200	S.IC	TC4S66F (TE85R)	
IC7	1180000800	S.IC	S-81350HG-KD-T1	
IC11	1110002400	S.IC	NJM2107F-TE1	
IC13	1130008370	S.IC	TC9260F (HR)	
IC15	1110005010	S.IC	MC33063ADR2	
IC16	1130006220	S.IC	TC4W53FU (TE12L)	
IC17	1130006220	S.IC	TC4W53FU (TE12L)	© only
IC18	1130006220	S.IC	TC4W53FU (TE12L)	© only
IC19	1110003780	S.IC	NJM2902V-TE1	
IC22	1130006220	S.IC	TC4W53FU (TE12L)	
IC26	1180000420	S.IC	TA78L05F (TE12R)	
IC28	1130004200	S.IC	TC4S66F (TE85R)	
IC29	1180002010	S.REG	BA08FP-E2	
IC30	1130004200	S.IC	TC4S66F (TE85R)	
IC31	1110002750	S.IC	TA75S01F (TE85R)	
IC37	1110003250	S.IC	TDA7233D (TDA7233D013TR)	
IC40	1110003200	S.IC	TA31136FN (EL)	
IC41	1110005030	IC	TA8208H	
IC42	1110002750	S.IC	TA75S01F (TE85R)	
IC43	1190001210	S.IC	HIP4081AIB-E2	
IC44	1110005130	S.IC	µPC311G2 (E2)	
IC45	1110005100	S.IC	NJM072BM-TE2	
IC46	1110005010	S.IC	MC33063ADR2	
IC47	1190001210	S.IC	HIP4081AIB-E2	
IC48	1130006220	S.IC	TC4W53FU (TE12L)	
IC50	1110002750	S.IC	TA75S01F (TE85R)	
IC51	1110002750	S.IC	TA75S01F (TE85R)	
Q1	1580000420	S.FET	3SK184-R (TX)	
Q2	1580000420	S.FET	3SK184-R (TX)	
Q3	1530002600	S.TRANSISTOR	2SC4215-O (TE85R)	
Q4	1530002600	S.TRANSISTOR	2SC4215-O (TE85R)	
Q5	1530002600	S.TRANSISTOR	2SC4215-O (TE85R)	
Q6	1530002600	S.TRANSISTOR	2SC4215-O (TE85R)	
Q7	1530003280	S.TRANSISTOR	2SC4211-6-TL	
Q11	1530002280	S.TRANSISTOR	2SC4081 T107 S	
Q12	1530002560	S.TRANSISTOR	2SC4403-3-TL	
Q14	1530002560	S.TRANSISTOR	2SC4403-3-TL	
Q15	1530002930	S.TRANSISTOR	2SC4228 (M) -T1 R45	
Q16	1530002850	S.TRANSISTOR	2SC4116-BL (TE85R)	
Q20	1560001100	S.FET	2SK3074 (TE12L)	
Q21	1560001060	S.FET	2SK3075 (TE12L)	
Q22	1530003280	S.TRANSISTOR	2SC4211-6-TL	
Q23	1520000460	S.TRANSISTOR	2SB1132 T100 R	
Q33	1590001980	S.TRANSISTOR	XP4315 (TX)	
Q42	1530002920	S.TRANSISTOR	2SC4226-T2 R25	
Q43	1530002920	S.TRANSISTOR	2SC4226-T2 R25	
Q44	1530002920	S.TRANSISTOR	2SC4226-T2 R25	
Q51	1590002840	FET	MRF137	
Q52	1510000880	S.TRANSISTOR	2SA1622-6-TL	
Q53	1590000980	S.TRANSISTOR	DTB123EK T147	
Q58	1590001810	S.TRANSISTOR	XP1113 (TX)	
Q59	1530002920	S.TRANSISTOR	2SC4226-T2 R25	
Q68	1590001980	S.TRANSISTOR	XP4315 (TX)	
Q69	1590000980	S.TRANSISTOR	DTB123EK T147	
Q70	1590000980	S.TRANSISTOR	DTB123EK T147	
Q71	1590001940	S.TRANSISTOR	DTC144EE TL	
Q72	1590001980	S.TRANSISTOR	XP4315 (TX)	
Q73	1530002060	S.TRANSISTOR	2SC4081 T107 R	
Q74	1520000200	S.TRANSISTOR	2SB798-T2 DK	
Q75	1530002060	S.TRANSISTOR	2SC4081 T107 R	
Q77	1540000520	S.TRANSISTOR	2SD1819A (TX) R	
Q78	1540000520	S.TRANSISTOR	2SD1819A (TX) R	
Q79	1560000530	S.FET	2SK880-GR (TE85R)	
Q80	1590000720	S.TRANSISTOR	DTA144EUA T106	
Q81	1590000430	S.TRANSISTOR	DTC144EUA T106	
Q82	1530002280	S.TRANSISTOR	2SC4081 T107 S	
Q83	1530002380	S.TRANSISTOR	2SC4215-Y (TE85R)	
Q84	1530002380	S.TRANSISTOR	2SC4215-Y (TE85R)	
Q86	1590001980	S.TRANSISTOR	XP4315 (TX)	
Q87	1560001120	S.FET	2SK2414-Z-E1	
Q88	1560001120	S.FET	2SK2414-Z-E1	
Q89	1590001170	S.TRANSISTOR	XP1501-(TX) .AB	
Q90	1510001020	TRANSISTOR	2SA1471R	
Q91	1560001120	S.FET	2SK2414-Z-E1	
Q92	1560001120	S.FET	2SK2414-Z-E1	
Q93	1560001120	S.FET	2SK2414-Z-E1	
Q94	1590002870	S.FET	FW215-TL	

(A): [A110EURO], (B): [USA-1] and [A110EURO], (C): [A110],
(D): [GEN-1] and [AUS]

[MAIN UNIT]

REF NO.	ORDER NO.		DESCRIPTION	
Q96	1590000430	S.TRANSISTOR	DTC144EUA T106	
Q97	1590000430	S.TRANSISTOR	DTC144EUA T106	
Q98	1510000770	S.TRANSISTOR	2SA1586-GR (TE85R)	
Q99	1530002850	S.TRANSISTOR	2SC4116-BL (TE85R)	
Q100	1590002870	S.FET	FW215-TL	
Q101	1590000430	S.TRANSISTOR	DTC144EUA T106	
Q102	1530002280	S.TRANSISTOR	2SC4081 T107 S	
D1	1750000760	S.DIODE	MA4PH224	
D2	1750000760	S.DIODE	MA4PH224	
D3	1750000510	S.DIODE	UM9401F	
D4	1790001670	S.DIODE	RB706F-40T106	
D5	1790001670	S.DIODE	RB706F-40T106	
D6	1720000780	S.VARICAP	HVU350B TRF	
D7	1720000780	S.VARICAP	HVU350B TRF	
D8	1720000780	S.VARICAP	HVU350B TRF	
D10	1790000620	S.DIODE	MA77 (TX)	
D11	1790000620	S.DIODE	MA77 (TX)	
D14	1790001330	S.ZENER	MA8036-L (TX)	
D15	1790001280	S.DIODE	MA111 (TX)	
D26	1790001340	S.DIODE	DE5SC6M-4061	
D27	1790001280	S.DIODE	MA111 (TX)	
D28	1750000580	S.DIODE	1SV307 (TPH3)	(B) only
D29	1750000580	S.DIODE	1SV307 (TPH3)	
D30	1750000580	S.DIODE	1SV307 (TPH3)	
D31	1750000580	S.DIODE	1SV307 (TPH3)	(B) only
D35	1730002460	S.ZENER	MA8330-M (TX)	
D36	1790000700	DIODE	DSA3A1	
D37	1720000780	S.VARICAP	HVU350B TRF	
D38	1750000530	S.DIODE	1SV271 (TPH3)	
D43	1750000260	S.DIODE	1SS352 (TPH3)	
D44	1730002320	S.ZENER	MA8051-M (TX)	
D50	1750000530	S.DIODE	1SV271 (TPH3)	
D51	1750000530	S.DIODE	1SV271 (TPH3)	
D52	1750000530	S.DIODE	1SV271 (TPH3)	
D53	1790001250	S.DIODE	MA2S111-(TX)	
D54	1790001250	S.DIODE	MA2S111-(TX)	
D55	1790000670	S.DIODE	SB07-03C-TB	
D56	1790001340	S.DIODE	DE5SC6M-4061	
D57	1750000050	S.DIODE	1SS193 (TE85R)	
D62	1790000670	S.DIODE	SB07-03C-TB	
D64	1720000780	S.VARICAP	HVU350B TRF	
D65	1720000780	S.VARICAP	HVU350B TRF	
D66	1790000670	S.DIODE	SB07-03C-TB	
F11	2010002400	S.MONOLITH	FL-306 (38.850 MHz)	
F12	2010002410	S.MONOLITH	FL-307 (38.850 MHz)	(B) only
F13	2020001540	CERAMIC	CFWM450D	
F14	2020001660	CERAMIC	CFG450H	(B) only
F15	4580000110	S.FILTER	ACF321825-223-T	
F16	2040000500	LC	BNX-002-01	
X1	6050010831	S.XTAL	CR-657A (12.8 MHz)	(C)
	6050010841	S.XTAL	CR-658A (12.8 MHz)	(A)
L2	6110001670	COIL	LA-253	
L3	6110001740	COIL	LA-263	
L4	6110001610	COIL	LA-244	
L5	6110001610	COIL	LA-244	
L6	6110001550	COIL	LA-235	
L7	6170000230	COIL	LW-25	
L8	6200003350	S.COIL	ELJNC R27K-F	
L9	6150005000	S.COIL	LS-527	
L10	6150005000	S.COIL	LS-527	
L11	6150005000	S.COIL	LS-527	
L12	6200002710	S.COIL	ELJFC 1R8K-F	
L14	6200001630	S.COIL	ELJNC R10K-F	
L15	6200003300	S.COIL	ELJNC R22K-F	
L17	6200003290	S.COIL	ELJNC R12K-F	
L19	6200005730	S.COIL	ELJRE 39NG-F	
L20	6200002380	S.COIL	LQN 1A 56NJ04	
L21	6200008400	S.COIL	0.35-1.6-6TL 36N	
L22	6200005740	S.COIL	ELJRE 47NG-F	
L23	6200008480	S.COIL	0.30-1.4-5TR 25N	
L26	6200003590	S.COIL	EXCCL3225U1	
L27	6200003350	S.COIL	ELJNC R27K-F	
L31	6200007000	S.COIL	ELJRE 82NG-F	
L33	6200004480	S.COIL	MLF1608D R82K-T	

S.=Surface mount

[MAIN UNIT]

REF NO.	ORDER NO.	DESCRIPTION	
L35	6200008270	S.COIL	0.26-1.0-5TL 17N
L36	6140000670	COIL	LR-89
L39	6200004480	S.COIL	MLF1608D R82K-T
L40	6200009080	S.COIL	MC152-E558CN-100025=P3
L41	6200004850	S.COIL	MC152-E558CN-100024
L42	6200004480	S.COIL	MLF1608D R82K-T
L43	6200004480	S.COIL	MLF1608D R82K-T
L48	6110001600	COIL	LA-243
L49	6150005000	S.COIL	LS-527
L50	6110001730	COIL	LA-262
L52	6200004480	S.COIL	MLF1608D R82K-T
L53	6190001500	COIL	HK-08S070-1310
L54	6200007000	S.COIL	ELJRE 82NG-F
L55	6200003310	S.COIL	ELJFC R33M-F
L56	6200003310	S.COIL	ELJFC R33M-F
L57	6200003310	S.COIL	ELJFC R33M-F
L60	6200005010	S.COIL	NL 252018T-100J
L61	6190001510	COIL	HK-10S080-1210
L62	6190001500	COIL	HK-08S070-1310
L63	6190001500	COIL	HK-08S070-1310
L64	6190001500	COIL	HK-08S070-1310
L65	6200005010	S.COIL	NL 252018T-100J
L67	6200008760	S.COIL	0.26-0.9-9TR 30N
L68	6200009120	S.COIL	0.20-0.7-4TR 8.8N
L69	6200008270	S.COIL	0.26-1.0-5TL 17N
L70	6110001520	COIL	LA-232
L71	6110002110	COIL	LA-382
L72	6200002040	S.COIL	NL 252018T-101J
L73	6200002040	S.COIL	NL 252018T-101J
L75	6200004480	S.COIL	MLF1608D R82K-T
L77	6200009140	S.COIL	NL 252018T-6R8J
L78	6190001520	S.COIL	ZBFS5101-PT
L79	6190001520	S.COIL	ZBFS5101-PT
L80	6190001520	S.COIL	ZBFS5101-PT
L81	6190001520	S.COIL	ZBFS5101-PT
L82	6200004450	S.COIL	ELJFC 6R8M-F
L83	6200004880	S.COIL	ELJFC 3R3K-F
L84	6200004880	S.COIL	ELJFC 3R3K-F
L85	6200004450	S.COIL	ELJFC 6R8M-F
L86	6190001520	S.COIL	ZBFS5101-PT
L87	6200006990	S.COIL	ELJRE 56NG-F
L88	6200004480	S.COIL	MLF1608D R82K-T
R1	7030006070	S.RESISTOR	ERJ12YJ101U (100 Ω)
R2	7030003480	S.RESISTOR	ERJ3GEYJ 222 V (2.2 kΩ)
R3	7030003500	S.RESISTOR	ERJ3GEYJ 332 V (3.3 kΩ)
R9	7030003720	S.RESISTOR	ERJ3GEYJ 224 V (220 kΩ)
R11	7030003800	S.RESISTOR	ERJ3GEYJ 105 V (1 MΩ)
R12	7030003730	S.RESISTOR	ERJ3GEYJ 274 V (270 kΩ)
R13	7030003680	S.RESISTOR	ERJ3GEYJ 104 V (100 kΩ)
R14	7030003770	S.RESISTOR	ERJ3GEYJ 564 V (560 kΩ)
R15	7030003280	S.RESISTOR	ERJ3GEYJ 470 V (47 Ω)
R16	7030003380	S.RESISTOR	ERJ3GEYJ 331 V (330 Ω)
R17	7030003280	S.RESISTOR	ERJ3GEYJ 470 V (47 Ω)
R18	7030003720	S.RESISTOR	ERJ3GEYJ 224 V (220 kΩ)
R19	7030003720	S.RESISTOR	ERJ3GEYJ 224 V (220 kΩ)
R20	7030003720	S.RESISTOR	ERJ3GEYJ 224 V (220 kΩ)
R21	7030003640	S.RESISTOR	ERJ3GEYJ 473 V (47 kΩ)
R24	7030003670	S.RESISTOR	ERJ3GEYJ 823 V (82 kΩ)
R25	7030003560	S.RESISTOR	ERJ3GEYJ 103 V (10 kΩ)
R26	7030003320	S.RESISTOR	ERJ3GEYJ 101 V (100 Ω)
R27	7030003470	S.RESISTOR	ERJ3GEYJ 182 V (1.8 kΩ)
R28	7030003320	S.RESISTOR	ERJ3GEYJ 101 V (100 Ω)
R30	7030003590	S.RESISTOR	ERJ3GEYJ 183 V (18 kΩ)
R31	7030003460	S.RESISTOR	ERJ3GEYJ 152 V (1.5 kΩ)
R34	7030003470	S.RESISTOR	ERJ3GEYJ 182 V (1.8 kΩ)
R35	7030003320	S.RESISTOR	ERJ3GEYJ 101 V (100 Ω)
R36	7030003600	S.RESISTOR	ERJ3GEYJ 223 V (22 kΩ)
R37	7030003650	S.RESISTOR	ERJ3GEYJ 563 V (56 kΩ)
R38	7030003460	S.RESISTOR	ERJ3GEYJ 152 V (1.5 kΩ)
R40	7030003480	S.RESISTOR	ERJ3GEYJ 222 V (2.2 kΩ)
R41	7030003600	S.RESISTOR	ERJ3GEYJ 223 V (22 kΩ)
R42	7030003460	S.RESISTOR	ERJ3GEYJ 152 V (1.5 kΩ)
R43	7030003500	S.RESISTOR	ERJ3GEYJ 332 V (3.3 kΩ)
R45	7030003650	S.RESISTOR	ERJ3GEYJ 563 V (56 kΩ)
R46	7030003320	S.RESISTOR	ERJ3GEYJ 101 V (100 Ω)
R48	7030003650	S.RESISTOR	ERJ3GEYJ 563 V (56 kΩ)
R49	7030003750	S.RESISTOR	ERJ3GEYJ 394 V (390 kΩ)
R50	7030003430	S.RESISTOR	ERJ3GEYJ 821 V (820 Ω)
R59	7310004660	S.TRIMMER	EVM-2WSX80 B54 (503)

[MAIN UNIT]

REF NO.	ORDER NO.	DESCRIPTION	
R61	7030003460	S.RESISTOR	ERJ3GEYJ 152 V (1.5 kΩ)
	7030003480	S.RESISTOR	ERJ3GEYJ 222 V (2.2 kΩ)
R62	7030003440	S.RESISTOR	ERJ3GEYJ 102 V (1 kΩ)
	7030003500	S.RESISTOR	ERJ3GEYJ 332 V (3.3 kΩ)
R63	7030003480	S.RESISTOR	ERJ3GEYJ 222 V (2.2 kΩ)
R64	7030003680	S.RESISTOR	ERJ3GEYJ 104 V (100 kΩ)
R65	7030003220	S.RESISTOR	ERJ3GEYJ 150 V (15 Ω)
R66	7030003220	S.RESISTOR	ERJ3GEYJ 150 V (15 Ω)
R67	7030003220	S.RESISTOR	ERJ3GEYJ 150 V (15 Ω)
R68	7030003480	S.RESISTOR	ERJ3GEYJ 222 V (2.2 kΩ)
R69	7030003700	S.RESISTOR	ERJ3GEYJ 154 V (150 kΩ)
R70	7030003400	S.RESISTOR	ERJ3GEYJ 471 V (470 Ω)
R71	7030003280	S.RESISTOR	ERJ3GEYJ 470 V (47 Ω)
R72	7030003660	S.RESISTOR	ERJ3GEYJ 683 V (68 kΩ)
R73	7030003370	S.RESISTOR	ERJ3GEYJ 271 V (270 Ω)
R74	7030003630	S.RESISTOR	ERJ3GEYJ 393 V (39 kΩ)
R75	7030003340	S.RESISTOR	ERJ3GEYJ 151 V (150 Ω)
R76	7030003560	S.RESISTOR	ERJ3GEYJ 103 V (10 kΩ)
R77	7030003560	S.RESISTOR	ERJ3GEYJ 103 V (10 kΩ)
R78	7030003300	S.RESISTOR	ERJ3GEYJ 680 V (68 Ω)
R79	7030003340	S.RESISTOR	ERJ3GEYJ 151 V (150 Ω)
R80	7030003300	S.RESISTOR	ERJ3GEYJ 680 V (68 Ω)
R85	7030003620	S.RESISTOR	ERJ3GEYJ 333 V (33 kΩ)
R86	7030003360	S.RESISTOR	ERJ3GEYJ 221 V (220 Ω)
R87	7030003330	S.RESISTOR	ERJ3GEYJ 121 V (120 Ω)
R95	7030003600	S.RESISTOR	ERJ3GEYJ 223 V (22 kΩ)
R99	7030003270	S.RESISTOR	ERJ3GEYJ 390 V (39 Ω)
R101	7030003510	S.RESISTOR	ERJ3GEYJ 392 V (3.9 kΩ)
	7030003560	S.RESISTOR	ERJ3GEYJ 103 V (10 kΩ)
R108	7030003440	S.RESISTOR	ERJ3GEYJ 102 V (1 kΩ)
R110	7310004530	S.TRIMMER	EVM-2WSX80 B14 (103)
R111	7030003680	S.RESISTOR	ERJ3GEYJ 104 V (100 kΩ)
R112	7030003270	S.RESISTOR	ERJ3GEYJ 390 V (39 Ω)
R113	7030003620	S.RESISTOR	ERJ3GEYJ 333 V (33 kΩ)
R114	7510001100	S.THERMISTOR	NTCCM1608 4LH 104KC
R115	7030003680	S.RESISTOR	ERJ3GEYJ 104 V (100 kΩ)
R116	7030003770	S.RESISTOR	ERJ3GEYJ 564 V (560 kΩ)
R117	7030003800	S.RESISTOR	ERJ3GEYJ 105 V (1 MΩ)
R118	7030003690	S.RESISTOR	ERJ3GEYJ 124 V (120 kΩ)
R119	7030003680	S.RESISTOR	ERJ3GEYJ 104 V (100 kΩ)
R120	7030003680	S.RESISTOR	ERJ3GEYJ 104 V (100 kΩ)
R121	7310004610	S.TRIMMER	EVM-2WSX80 B15 (104)
R122	7030003630	S.RESISTOR	ERJ3GEYJ 393 V (39 kΩ)
R123	7030003630	S.RESISTOR	ERJ3GEYJ 393 V (39 kΩ)
R124	7030003630	S.RESISTOR	ERJ3GEYJ 393 V (39 kΩ)
R126	7030003560	S.RESISTOR	ERJ3GEYJ 103 V (10 kΩ)
R127	7030003560	S.RESISTOR	ERJ3GEYJ 103 V (10 kΩ)
R128	7030003560	S.RESISTOR	ERJ3GEYJ 103 V (10 kΩ)
R131	7030003440	S.RESISTOR	ERJ3GEYJ 102 V (1 kΩ)
R132	7030003560	S.RESISTOR	ERJ3GEYJ 103 V (10 kΩ)
R148	7030003600	S.RESISTOR	ERJ3GEYJ 223 V (22 kΩ)
R149	7030003520	S.RESISTOR	ERJ3GEYJ 472 V (4.7 kΩ)
R150	7310004530	S.TRIMMER	EVM-2WSX80 B14 (103)
R151	7030003500	S.RESISTOR	ERJ3GEYJ 332 V (3.3 kΩ)
R152	7030003320	S.RESISTOR	ERJ3GEYJ 101 V (100 Ω)
R153	7030003540	S.RESISTOR	ERJ3GEYJ 682 V (6.8 kΩ)
R174	7030003650	S.RESISTOR	ERJ3GEYJ 563 V (56 kΩ)
R181	7030003700	S.RESISTOR	ERJ3GEYJ 154 V (150 kΩ)
R182	7030003760	S.RESISTOR	ERJ3GEYJ 474 V (470 kΩ)
R183	7030003800	S.RESISTOR	ERJ3GEYJ 105 V (1 MΩ)
R184	7030003800	S.RESISTOR	ERJ3GEYJ 105 V (1 MΩ)
R186	7030003700	S.RESISTOR	ERJ3GEYJ 154 V (150 kΩ)
R187	7030003680	S.RESISTOR	ERJ3GEYJ 104 V (100 kΩ)
R188	7030003640	S.RESISTOR	ERJ3GEYJ 473 V (47 kΩ)
R192	7030003660	S.RESISTOR	ERJ3GEYJ 683 V (68 kΩ)
R193	7030003400	S.RESISTOR	ERJ3GEYJ 471 V (470 Ω)
R194	7030003490	S.RESISTOR	ERJ3GEYJ 272 V (2.7 kΩ)
R208	7030003320	S.RESISTOR	ERJ3GEYJ 101 V (100 Ω)
R209	7030003640	S.RESISTOR	ERJ3GEYJ 473 V (47 kΩ)
R211	7030003540	S.RESISTOR	ERJ3GEYJ 682 V (6.8 kΩ)
R212	7030003440	S.RESISTOR	ERJ3GEYJ 102 V (1 kΩ)
R218	7030003520	S.RESISTOR	ERJ3GEYJ 472 V (4.7 kΩ)
R219	7030000210	S.RESISTOR	MCR10EZJH 39 Ω (390)
R220	7030003550	S.RESISTOR	ERJ3GEYJ 822 V (8.2 kΩ)
R221	7030000520	S.RESISTOR	MCR10EZJH 15 kΩ
R223	7030003620	S.RESISTOR	ERJ3GEYJ 333 V (33 kΩ)
R224	7030003440	S.RESISTOR	ERJ3GEYJ 102 V (1 kΩ)
R225	7030003560	S.RESISTOR	ERJ3GEYJ 103 V (10 kΩ)
R226	7030003680	S.RESISTOR	ERJ3GEYJ 104 V (100 kΩ)
R228	7030003480	S.RESISTOR	ERJ3GEYJ 222 V (2.2 kΩ)
R229	7030003480	S.RESISTOR	ERJ3GEYJ 222 V (2.2 kΩ)
R230	7030003520	S.RESISTOR	ERJ3GEYJ 472 V (4.7 kΩ)

Ⓐ: [A110EURO], Ⓑ: [USA/-1] and [A110EURO], Ⓒ: [A110],
 Ⓓ: [GEN/-1] and [AUS]

S.=Surface mount

[MAIN UNIT]

REF NO.	ORDER NO.	DESCRIPTION	
R231	7030003520	S.RESISTOR	ERJ3GEYJ 472 V (4.7 kΩ) [ⓑ] only
R232	7030003520	S.RESISTOR	ERJ3GEYJ 472 V (4.7 kΩ)
R233	7030003520	S.RESISTOR	ERJ3GEYJ 472 V (4.7 kΩ)
R234	7030003600	S.RESISTOR	ERJ3GEYJ 223 V (22 kΩ)
R235	7030003600	S.RESISTOR	ERJ3GEYJ 223 V (22 kΩ)
R236	7030003600	S.RESISTOR	ERJ3GEYJ 223 V (22 kΩ)
R237	7030003600	S.RESISTOR	ERJ3GEYJ 223 V (22 kΩ)
R238	7030003600	S.RESISTOR	ERJ3GEYJ 223 V (22 kΩ)
R239	7030003600	S.RESISTOR	ERJ3GEYJ 223 V (22 kΩ)
R240	7030003600	S.RESISTOR	ERJ3GEYJ 223 V (22 kΩ)
R241	7030003600	S.RESISTOR	ERJ3GEYJ 223 V (22 kΩ)
R242	7030003600	S.RESISTOR	ERJ3GEYJ 223 V (22 kΩ)
R243	7030003320	S.RESISTOR	ERJ3GEYJ 101 V (100 Ω)
R251	7030003520	S.RESISTOR	ERJ3GEYJ 472 V (4.7 kΩ)
R256	7030003490	S.RESISTOR	ERJ3GEYJ 272 V (2.7 kΩ)
R267	7030003560	S.RESISTOR	ERJ3GEYJ 103 V (10 kΩ)
R273	7030003760	S.RESISTOR	ERJ3GEYJ 474 V (470 kΩ)
R280	7030003560	S.RESISTOR	ERJ3GEYJ 103 V (10 kΩ)
R281	7030003750	S.RESISTOR	ERJ3GEYJ 394 V (390 kΩ)
R288	7030003440	S.RESISTOR	ERJ3GEYJ 102 V (1 kΩ)
R289	7030003720	S.RESISTOR	ERJ3GEYJ 224 V (220 kΩ)
R295	7030003350	S.RESISTOR	ERJ3GEYJ 181 V (180 Ω)
R297	7030003760	S.RESISTOR	ERJ3GEYJ 474 V (470 kΩ)
R301	7030003600	S.RESISTOR	ERJ3GEYJ 223 V (22 kΩ)
R321	7030003640	S.RESISTOR	ERJ3GEYJ 473 V (47 kΩ)
R322	7030004040	S.RESISTOR	ERJ3GEYJ 4R7 V (4.7 Ω)
R323	7030003560	S.RESISTOR	ERJ3GEYJ 103 V (10 kΩ)
R325	7030003370	S.RESISTOR	ERJ3GEYJ 271 V (270 Ω)
R327	7030003340	S.RESISTOR	ERJ3GEYJ 151 V (150 Ω)
R328	7030003650	S.RESISTOR	ERJ3GEYJ 563 V (56 kΩ)
R329	7030003690	S.RESISTOR	ERJ3GEYJ 124 V (120 kΩ)
R330	7510001000	S.THERMISTOR	TBPS1R154K475H5Q
R331	7030003720	S.RESISTOR	ERJ3GEYJ 224 V (220 kΩ)
R332	7030003690	S.RESISTOR	ERJ3GEYJ 124 V (120 kΩ)
R333	7030003560	S.RESISTOR	ERJ3GEYJ 103 V (10 kΩ)
R334	7030003770	S.RESISTOR	ERJ3GEYJ 564 V (560 kΩ)
R335	7030004050	S.RESISTOR	ERJ3GEYJ 1R0 V (1 Ω)
R336	7310004590	S.TRIMMER	EVM-2WSX80 B13 (102)
R338	7030003560	S.RESISTOR	ERJ3GEYJ 103 V (10 kΩ)
R340	7030003410	S.RESISTOR	ERJ3GEYJ 561 V (560 Ω)
R342	7030003560	S.RESISTOR	ERJ3GEYJ 103 V (10 kΩ)
R355	7030003480	S.RESISTOR	ERJ3GEYJ 222 V (2.2 kΩ)
R356	7030003660	S.RESISTOR	ERJ3GEYJ 683 V (68 kΩ)
R357	7030003800	S.RESISTOR	ERJ3GEYJ 105 V (1 MΩ)
R358	7030003670	S.RESISTOR	ERJ3GEYJ 823 V (82 kΩ)
R359	7030003320	S.RESISTOR	ERJ3GEYJ 101 V (100 Ω)
R361	7030003800	S.RESISTOR	ERJ3GEYJ 105 V (1 MΩ)
R362	7030003450	S.RESISTOR	ERJ3GEYJ 122 V (1.2 kΩ)
R363	7030003680	S.RESISTOR	ERJ3GEYJ 104 V (100 kΩ)
R364	7030003810	S.RESISTOR	ERJ3GEYJ 125 V (1.2 MΩ)
R365	7030003680	S.RESISTOR	ERJ3GEYJ 104 V (100 kΩ)
R366	7030003680	S.RESISTOR	ERJ3GEYJ 104 V (100 kΩ)
R367	7030003560	S.RESISTOR	ERJ3GEYJ 103 V (10 kΩ)
R368	7030003590	S.RESISTOR	ERJ3GEYJ 183 V (18 kΩ)
R369	7030003560	S.RESISTOR	ERJ3GEYJ 103 V (10 kΩ)
R370	7030003560	S.RESISTOR	ERJ3GEYJ 103 V (10 kΩ)
R371	7030003560	S.RESISTOR	ERJ3GEYJ 103 V (10 kΩ)
R372	7030003320	S.RESISTOR	ERJ3GEYJ 101 V (100 Ω)
R373	7030003320	S.RESISTOR	ERJ3GEYJ 101 V (100 Ω)
R374	7030003680	S.RESISTOR	ERJ3GEYJ 104 V (100 kΩ)
R375	7030003530	S.RESISTOR	ERJ3GEYJ 562 V (5.6 kΩ)
R376	7030003770	S.RESISTOR	ERJ3GEYJ 564 V (560 kΩ)
R377	7030003240	S.RESISTOR	ERJ3GEYJ 220 V (22 Ω)
R378	7030003560	S.RESISTOR	ERJ3GEYJ 103 V (10 kΩ)
R379	7030003680	S.RESISTOR	ERJ3GEYJ 104 V (100 kΩ)
R380	7030006060	S.RESISTOR	ERJ12YJ100U (10 Ω)
R381	7030003580	S.RESISTOR	ERJ3GEYJ 153 V (15 kΩ)
R383	7030003560	S.RESISTOR	ERJ3GEYJ 103 V (10 kΩ)
R386	7030003700	S.RESISTOR	ERJ3GEYJ 154 V (150 kΩ)
R387	7030003700	S.RESISTOR	ERJ3GEYJ 154 V (150 kΩ)
R388	7030003520	S.RESISTOR	ERJ3GEYJ 472 V (4.7 kΩ)
R389	7030003490	S.RESISTOR	ERJ3GEYJ 272 V (2.7 kΩ)
R390	7030003410	S.RESISTOR	ERJ3GEYJ 561 V (560 Ω)
R391	7030003400	S.RESISTOR	ERJ3GEYJ 471 V (470 Ω)
R392	7310004670	S.TRIMMER	EVM-2WSX80 B55 (504)
R393	7030003580	S.RESISTOR	ERJ3GEYJ 153 V (15 kΩ)
R394	7030003580	S.RESISTOR	ERJ3GEYJ 153 V (15 kΩ)
R395	7030003650	S.RESISTOR	ERJ3GEYJ 563 V (56 kΩ)
R396	7030003640	S.RESISTOR	ERJ3GEYJ 473 V (47 kΩ)
R397	7030003640	S.RESISTOR	ERJ3GEYJ 473 V (47 kΩ)
R398	7030003480	S.RESISTOR	ERJ3GEYJ 222 V (2.2 kΩ)
R399	7030003440	S.RESISTOR	ERJ3GEYJ 102 V (1 kΩ)

Ⓐ: [A110EURO], Ⓑ: [USA/-1] and [A110EURO], Ⓒ: [A110],
 Ⓓ: [GEN/-1] and [AUS]

[MAIN UNIT]

REF NO.	ORDER NO.	DESCRIPTION	
R400	7030003440	S.RESISTOR	ERJ3GEYJ 102 V (1 kΩ)
R401	7030003480	S.RESISTOR	ERJ3GEYJ 222 V (2.2 kΩ)
R403	7030003480	S.RESISTOR	ERJ3GEYJ 222 V (2.2 kΩ)
R404	7030003480	S.RESISTOR	ERJ3GEYJ 222 V (2.2 kΩ)
R405	7030003650	S.RESISTOR	ERJ3GEYJ 563 V (56 kΩ)
R406	7030003470	S.RESISTOR	ERJ3GEYJ 182 V (1.8 kΩ)
R407	7030003700	S.RESISTOR	ERJ3GEYJ 154 V (150 kΩ)
R408	7030003700	S.RESISTOR	ERJ3GEYJ 154 V (150 kΩ)
R409	7030004890	S.RESISTOR	ERJ3GEYF 434 V (430 kΩ)
R410	7030004860	S.RESISTOR	ERJ3GEYF 184 V (180 kΩ)
R411	7030005260	S.RESISTOR	ERJ3GEYF 394 V (390 kΩ)
R412	7030003560	S.RESISTOR	ERJ3GEYJ 103 V (10 kΩ)
R413	7030003550	S.RESISTOR	ERJ3GEYJ 822 V (8.2 kΩ)
R414	7030003550	S.RESISTOR	ERJ3GEYJ 822 V (8.2 kΩ)
R415	7030003440	S.RESISTOR	ERJ3GEYJ 102 V (1 kΩ)
R417	7030003480	S.RESISTOR	ERJ3GEYJ 222 V (2.2 kΩ)
R418	7030003760	S.RESISTOR	ERJ3GEYJ 474 V (470 kΩ)
R419	7030003560	S.RESISTOR	ERJ3GEYJ 103 V (10 kΩ)
R420	7030003480	S.RESISTOR	ERJ3GEYJ 222 V (2.2 kΩ)
R422	7030003800	S.RESISTOR	ERJ3GEYJ 105 V (1 MΩ)
R423	7030003320	S.RESISTOR	ERJ3GEYJ 101 V (100 Ω)
R424	7030003680	S.RESISTOR	ERJ3GEYJ 104 V (100 kΩ)
R425	7030003600	S.RESISTOR	ERJ3GEYJ 223 V (22 kΩ)
R426	7030003640	S.RESISTOR	ERJ3GEYJ 473 V (47 kΩ)
R427	7030003620	S.RESISTOR	ERJ3GEYJ 333 V (33 kΩ)
R428	7030003380	S.RESISTOR	ERJ3GEYJ 331 V (330 Ω)
R429	7030003560	S.RESISTOR	ERJ3GEYJ 103 V (10 kΩ)
R430	7030003570	S.RESISTOR	ERJ3GEYJ 123 V (12 kΩ)
R431	7030003490	S.RESISTOR	ERJ3GEYJ 272 V (2.7 kΩ)
R432	7030003540	S.RESISTOR	ERJ3GEYJ 682 V (6.8 kΩ)
R433	7030003640	S.RESISTOR	ERJ3GEYJ 473 V (47 kΩ)
R434	7030003560	S.RESISTOR	ERJ3GEYJ 103 V (10 kΩ)
R435	7030000410	S.RESISTOR	MCR10EZHH 1.8 kΩ
R436	7030003620	S.RESISTOR	ERJ3GEYJ 333 V (33 kΩ)
R437	7030003440	S.RESISTOR	ERJ3GEYJ 102 V (1 kΩ)
R438	7030003400	S.RESISTOR	ERJ3GEYJ 471 V (470 Ω)
R439	7030003400	S.RESISTOR	ERJ3GEYJ 471 V (470 Ω)
R440	7030003560	S.RESISTOR	ERJ3GEYJ 103 V (10 kΩ)
R441	7030003500	S.RESISTOR	ERJ3GEYJ 332 V (3.3 kΩ)
R442	7030003560	S.RESISTOR	ERJ3GEYJ 103 V (10 kΩ)
R443	7030003560	S.RESISTOR	ERJ3GEYJ 103 V (10 kΩ)
R444	7030003560	S.RESISTOR	ERJ3GEYJ 103 V (10 kΩ)
R445	7030003430	S.RESISTOR	ERJ3GEYJ 821 V (820 Ω)
R446	7030003550	S.RESISTOR	ERJ3GEYJ 822 V (8.2 kΩ)
R447	7030003450	S.RESISTOR	ERJ3GEYJ 122 V (1.2 kΩ)
R448	7030003420	S.RESISTOR	ERJ3GEYJ 681 V (680 Ω)
R449	7030003280	S.RESISTOR	ERJ3GEYJ 470 V (47 Ω)
R450	7030003560	S.RESISTOR	ERJ3GEYJ 103 V (10 kΩ)
R451	7030004040	S.RESISTOR	ERJ3GEYJ 4R7 V (4.7 Ω)
R452	7030003530	S.RESISTOR	ERJ3GEYJ 562 V (5.6 kΩ)
R453	7030003440	S.RESISTOR	ERJ3GEYJ 102 V (1 kΩ)
R454	7030003520	S.RESISTOR	ERJ3GEYJ 472 V (4.7 kΩ)
R455	7030003450	S.RESISTOR	ERJ3GEYJ 122 V (1.2 kΩ)
R456	7030003720	S.RESISTOR	ERJ3GEYJ 224 V (220 kΩ)
R457	7030003700	S.RESISTOR	ERJ3GEYJ 154 V (150 kΩ)
R458	7030003440	S.RESISTOR	ERJ3GEYJ 102 V (1 kΩ)
R459	7030003560	S.RESISTOR	ERJ3GEYJ 103 V (10 kΩ)
R460	7030004040	S.RESISTOR	ERJ3GEYJ 4R7 V (4.7 Ω)
R461	7030003530	S.RESISTOR	ERJ3GEYJ 562 V (5.6 kΩ)
R462	7030003560	S.RESISTOR	ERJ3GEYJ 103 V (10 kΩ)
R463	7030003760	S.RESISTOR	ERJ3GEYJ 474 V (470 kΩ)
R464	7030003500	S.RESISTOR	ERJ3GEYJ 332 V (3.3 kΩ)
R465	7030003560	S.RESISTOR	ERJ3GEYJ 103 V (10 kΩ)
R466	7030003560	S.RESISTOR	ERJ3GEYJ 103 V (10 kΩ)
R467	7030003800	S.RESISTOR	ERJ3GEYJ 105 V (1 MΩ)
R468	7030006120	S.RESISTOR	ERJ1WYJ4R7U (4.7 Ω)
R469	7030006120	S.RESISTOR	ERJ1WYJ4R7U (4.7 Ω)
R470	7030003600	S.RESISTOR	ERJ3GEYJ 223 V (22 kΩ)
R471	7030003600	S.RESISTOR	ERJ3GEYJ 223 V (22 kΩ)
R472	7030003680	S.RESISTOR	ERJ3GEYJ 104 V (100 kΩ)
R473	7030001160	S.RESISTOR	MCR50JZHJ 180 Ω (181)
R474	7030004040	S.RESISTOR	ERJ3GEYJ 4R7 V (4.7 Ω)
R475	7030003520	S.RESISTOR	ERJ3GEYJ 472 V (4.7 kΩ)
R476	7030003440	S.RESISTOR	ERJ3GEYJ 102 V (1 kΩ)
R478	7030003670	S.RESISTOR	ERJ3GEYJ 823 V (82 kΩ)
R479	7510001100	S.THERMISTOR	NTCCM1608 4LH 104KC
R484	7030003510	S.RESISTOR	ERJ3GEYJ 392 V (3.9 kΩ)
R485	7030003440	S.RESISTOR	ERJ3GEYJ 102 V (1 kΩ) [Ⓐ] only

S.=Surface mount

[MAIN UNIT]

REF NO.	ORDER NO.	DESCRIPTION
C1	4030011210	S.CERAMIC GRM42-6 CH 330J 500PT
C2	4030011070	S.CERAMIC GRM42-6 CH 050C 500PT
C3	4030011230	S.CERAMIC GRM42-6 CH 390J 500PT
C4	4030011030	S.CERAMIC GRM42-6 CK 1R5C 500PT
C5	4030011180	S.CERAMIC GRM42-6 CH 220J 500PT
C6	4030017200	S.CERAMIC GHM1030 R 102K 630PT
C7	4030011180	S.CERAMIC GRM42-6 CH 220J 500PT
C8	4030007080	S.CERAMIC C1608 CH 1H 390J-T-A
C9	4030007040	S.CERAMIC C1608 CH 1H 180J-T-A
C10	4030007100	S.CERAMIC C1608 CH 1H 560J-T-A
C11	4030017200	S.CERAMIC GHM1030 R 102K 630PT
C12	4030011180	S.CERAMIC GRM42-6 CH 220J 500PT
C13	4030011020	S.CERAMIC GRM42-6 CK 010C 500PT
C14	4030011020	S.CERAMIC GRM42-6 CK 010C 500PT
C15	4030011180	S.CERAMIC GRM42-6 CH 220J 500PT
C16	4030011120	S.CERAMIC GRM42-6 CH 100D 500PT
C17	4030011120	S.CERAMIC GRM42-6 CH 100D 500PT
C18	4030006860	S.CERAMIC C1608 JB 1H 102K-T-A
C19	4030006860	S.CERAMIC C1608 JB 1H 102K-T-A
C20	4030017200	S.CERAMIC GHM1030 R 102K 630PT
C21	4030007010	S.CERAMIC C1608 CH 1H 100D-T-A
C22	4030007050	S.CERAMIC C1608 CH 1H 220J-T-A
C23	4030009560	S.CERAMIC C1608 CH 1H R75B-T-A
C24	4030006860	S.CERAMIC C1608 JB 1H 102K-T-A
C25	4030006860	S.CERAMIC C1608 JB 1H 102K-T-A
C26	4030006860	S.CERAMIC C1608 JB 1H 102K-T-A
C27	4030006860	S.CERAMIC C1608 JB 1H 102K-T-A
C28	4030006860	S.CERAMIC C1608 JB 1H 102K-T-A
C29	4030007060	S.CERAMIC C1608 CH 1H 270J-T-A
C30	4030006860	S.CERAMIC C1608 JB 1H 102K-T-A
C31	4030009500	S.CERAMIC C1608 CH 1H 0R5B-T-A
C32	4030007060	S.CERAMIC C1608 CH 1H 270J-T-A
C33	4030009530	S.CERAMIC C1608 CH 1H 030B-T-A
C34	4030006860	S.CERAMIC C1608 JB 1H 102K-T-A
C36	4030006860	S.CERAMIC C1608 JB 1H 102K-T-A
C37	4030006860	S.CERAMIC C1608 JB 1H 102K-T-A
C39	4030006900	S.CERAMIC C1608 JB 1E 103K-T-A
C40	4030006860	S.CERAMIC C1608 JB 1H 102K-T-A
C41	4030006900	S.CERAMIC C1608 JB 1E 103K-T-A
C42	4030006900	S.CERAMIC C1608 JB 1E 103K-T-A
C43	4030006860	S.CERAMIC C1608 JB 1H 102K-T-A
C44	4030011600	S.CERAMIC C1608 JB 1C 104KT-N
C46	4030006900	S.CERAMIC C1608 JB 1E 103K-T-A
C47	4030011600	S.CERAMIC C1608 JB 1C 104KT-N
C48	4030011600	S.CERAMIC C1608 JB 1C 104KT-N
C50	4030011600	S.CERAMIC C1608 JB 1C 104KT-N
C51	4030006900	S.CERAMIC C1608 JB 1E 103K-T-A
C52	4030011600	S.CERAMIC C1608 JB 1C 104KT-N
C53	4030006900	S.CERAMIC C1608 JB 1E 103K-T-A
C54	4030006900	S.CERAMIC C1608 JB 1E 103K-T-A
C55	4030006900	S.CERAMIC C1608 JB 1E 103K-T-A
C56	4550006560	S.TANTALUM ECST1CY225R
C58	4510004440	S.ELECTROLYTIC ECEV1HA010SR
C59	4550006360	S.TANTALUM ECST1VY104R
C60	4550006140	S.TANTALUM ECST1EY474R
	4550006150	S.TANTALUM ECST1CY105R
C61	4030006860	S.CERAMIC C1608 JB 1H 102K-T-A
C62	4030006860	S.CERAMIC C1608 JB 1H 102K-T-A
C63	4030006860	S.CERAMIC C1608 JB 1H 102K-T-A
C68	4030006860	S.CERAMIC C1608 JB 1H 102K-T-A
C69	4030006860	S.CERAMIC C1608 JB 1H 102K-T-A
C70	4030006860	S.CERAMIC C1608 JB 1H 102K-T-A
C71	4030006860	S.CERAMIC C1608 JB 1H 102K-T-A
C72	4030009990	S.CERAMIC C1608 CH 1H 200J-T-A
C73	4030006860	S.CERAMIC C1608 JB 1H 102K-T-A
C74	4030007040	S.CERAMIC C1608 CH 1H 180J-T-A
C75	4030006860	S.CERAMIC C1608 JB 1H 102K-T-A
C77	4030006860	S.CERAMIC C1608 JB 1H 102K-T-A
C78	4030009990	S.CERAMIC C1608 CH 1H 200J-T-A
C82	4030006860	S.CERAMIC C1608 JB 1H 102K-T-A
C85	4030006860	S.CERAMIC C1608 JB 1H 102K-T-A
C87	4030007030	S.CERAMIC C1608 CH 1H 150J-T-A
C91	4030006860	S.CERAMIC C1608 JB 1H 102K-T-A
C92	4030006860	S.CERAMIC C1608 JB 1H 102K-T-A
C95	4030007060	S.CERAMIC C1608 CH 1H 270J-T-A
C96	4030006860	S.CERAMIC C1608 JB 1H 102K-T-A
C97	4030006860	S.CERAMIC C1608 JB 1H 102K-T-A
C98	4030007030	S.CERAMIC C1608 CH 1H 150J-T-A
C99	4030006860	S.CERAMIC C1608 JB 1H 102K-T-A
C100	4030006860	S.CERAMIC C1608 JB 1H 102K-T-A
C101	4030007070	S.CERAMIC C1608 CH 1H 330J-T-A
C102	4030007050	S.CERAMIC C1608 CH 1H 220J-T-A

[MAIN UNIT]

REF NO.	ORDER NO.	DESCRIPTION
C103	4030007100	S.CERAMIC C1608 CH 1H 560J-T-A
C110	4030012600	S.CERAMIC C2012 JB 1A 105M-T-A
C112	4550006220	S.TANTALUM TEMSVA 0J 156M-8L
C113	4510004630	S.ELECTROLYTIC ECEV1CA100SR
C114	4550006140	S.TANTALUM ECST1EY474R
C115	4030006860	S.CERAMIC C1608 JB 1H 102K-T-A
C116	4030006900	S.CERAMIC C1608 JB 1E 103K-T-A
C117	4030009970	S.CERAMIC C1608 JB 1H 182K-T-A
C118	4030009630	S.CERAMIC C1608 JB 1H 102K-T-A
C119	4030007130	S.CERAMIC C1608 CH 1H 101J-T-A
C120	4030012610	S.CERAMIC C2012 JB 1C 474K-T-A
C121	4030006900	S.CERAMIC C1608 JB 1E 103K-T-A
C122	4030006860	S.CERAMIC C1608 JB 1H 102K-T-A
C123	4550006220	S.TANTALUM TEMSVA 0J 156M-8L
C124	4030006860	S.CERAMIC C1608 JB 1H 102K-T-A
C126	4030011600	S.CERAMIC C1608 JB 1C 104KT-N
C127	4030006900	S.CERAMIC C1608 JB 1E 103K-T-A
C128	4030011600	S.CERAMIC C1608 JB 1C 104KT-N
C129	4510007460	S.ELECTROLYTIC 10 SV 22M
C130	4030006860	S.CERAMIC C1608 JB 1H 102K-T-A
C131	4030006860	S.CERAMIC C1608 JB 1H 102K-T-A
C132	4550006710	S.TANTALUM ECST1AX226R
C133	4550006140	S.TANTALUM ECST1EY474R
C134	4550006710	S.TANTALUM ECST1AX226R
C135	4030006860	S.CERAMIC C1608 JB 1H 102K-T-A
C138	4510004630	S.ELECTROLYTIC ECEV1CA100SR
C139	4030006860	S.CERAMIC C1608 JB 1H 102K-T-A
C140	4030006860	S.CERAMIC C1608 JB 1H 102K-T-A
C141	4030006860	S.CERAMIC C1608 JB 1H 102K-T-A
C148	4030006860	S.CERAMIC C1608 JB 1H 102K-T-A
C149	4030006860	S.CERAMIC C1608 JB 1H 102K-T-A
C153	4030012600	S.CERAMIC C2012 JB 1A 105M-T-A
C154	4030007050	S.CERAMIC C1608 CH 1H 220J-T-A
C156	4030011600	S.CERAMIC C1608 JB 1C 104KT-N
C164	4030007010	S.CERAMIC C1608 CH 1H 100D-T-A
C165	4030007060	S.CERAMIC C1608 CH 1H 270J-T-A
C167	4030006860	S.CERAMIC C1608 JB 1H 102K-T-A
C168	4510005950	S.ELECTROLYTIC ECEV1HA0R1SR
C170	4030012600	S.CERAMIC C2012 JB 1A 105M-T-A
C175	4550006540	S.TANTALUM ECST1CY475R
C177	4550006300	S.TANTALUM ECST1AY475R
C188	4030007070	S.CERAMIC C1608 CH 1H 330J-T-A
C189	4030006860	S.CERAMIC C1608 JB 1H 102K-T-A
C190	4030009500	S.CERAMIC C1608 CH 1H 0R5B-T-A
C192	4030007010	S.CERAMIC C1608 CH 1H 100D-T-A
	4030007030	S.CERAMIC C1608 CH 1H 150J-T-A
	4030006860	S.CERAMIC C1608 JB 1H 102K-T-A
C193	4030007040	S.CERAMIC C1608 CH 1H 180J-T-A
C195	4030009990	S.CERAMIC C1608 CH 1H 200J-T-A
	4510006670	S.ELECTROLYTIC ECEV1CA471P
C206	4030007130	S.CERAMIC C1608 CH 1H 101J-T-A
C209	4030012610	S.CERAMIC C2012 JB 1C 474K-T-A
C211	4510007320	ELECTROLYTIC 50 YXG 470M
C212	4510007320	ELECTROLYTIC 50 YXG 470M
C213	4030006860	S.CERAMIC C1608 JB 1H 102K-T-A
C214	4030006860	S.CERAMIC C1608 JB 1H 102K-T-A
C217	4030007080	S.CERAMIC C1608 CH 1H 390J-T-A
C218	4030006860	S.CERAMIC C1608 JB 1H 102K-T-A
C220	4030006860	S.CERAMIC C1608 JB 1H 102K-T-A
C224	4030011600	S.CERAMIC C1608 JB 1C 104KT-N
C226	4550005980	S.TANTALUM TEMSVA 1A 475M-8L
C228	4030006900	S.CERAMIC C1608 JB 1E 103K-T-A
C229	4030006900	S.CERAMIC C1608 JB 1E 103K-T-A
C230	4030006900	S.CERAMIC C1608 JB 1E 103K-T-A
C231	4030006860	S.CERAMIC C1608 JB 1H 102K-T-A
C232	4030010210	S.CERAMIC C3216 JB 1C 105M-T-A
C233	4030012600	S.CERAMIC C2012 JB 1A 105M-T-A
C234	4030012600	S.CERAMIC C2012 JB 1A 105M-T-A
C235	4030006900	S.CERAMIC C1608 JB 1E 103K-T-A
C241	4030011190	S.CERAMIC GRM42-6 CH 270J 500PT
C242	4030017080	S.CERAMIC GRH111 CH 820J 500PT
C249	4030006860	S.CERAMIC C1608 JB 1H 102K-T-A
C250	4030006860	S.CERAMIC C1608 JB 1H 102K-T-A
C251	4030006860	S.CERAMIC C1608 JB 1H 102K-T-A
C253	4030006860	S.CERAMIC C1608 JB 1H 102K-T-A
C255	4030006860	S.CERAMIC C1608 JB 1H 102K-T-A
C256	4030008880	S.CERAMIC C1608 JB 1C 223K-T-A
C257	4030009970	S.CERAMIC C1608 JB 1H 182K-T-A
C258	4030006900	S.CERAMIC C1608 JB 1E 103K-T-A
C259	4030008860	S.CERAMIC C1608 JB 1C 153K-T-A
C260	4030006860	S.CERAMIC C1608 JB 1H 102K-T-A

Ⓐ: [A110EURO], Ⓑ: [USA-1] and [A110EURO], Ⓒ: [A110],
 Ⓓ: [GEN/-1] and [AUS]

S.=Surface mount

[MAIN UNIT]

REF NO.	ORDER NO.	DESCRIPTION
C261	4030008880	S.CERAMIC C1608 JB 1C 223K-T-A
C262	4030011340	S.CERAMIC C1608 CH 1H 471J-T-A
C263	4030012660	S.CERAMIC C1608 JB 1C 683K-T-N
C264	4030007120	S.CERAMIC C1608 CH 1H 820J-T-A
C265	4030011600	S.CERAMIC C1608 JB 1C 104KT-N
C266	4030011600	S.CERAMIC C1608 JB 1C 104KT-N
C267	4030011600	S.CERAMIC C1608 JB 1C 104KT-N
C268	4030011600	S.CERAMIC C1608 JB 1C 104KT-N
C277	4030006860	S.CERAMIC C1608 JB 1H 102K-T-A
C279	4030007000	S.CERAMIC C1608 CH 1H 090D-T-A
C286	4030009500	S.CERAMIC C1608 CH 1H 0R5B-T-A
C288	4030006860	S.CERAMIC C1608 JB 1H 102K-T-A
C289	4030011600	S.CERAMIC C1608 JB 1C 104KT-N
C290	4030011600	S.CERAMIC C1608 JB 1C 104KT-N
C292	4030008920	S.CERAMIC C1608 JB 1C 473K-T-A
C293	4030010760	S.CERAMIC C1608 CH 1H 331J-T-A
C295	4030006860	S.CERAMIC C1608 JB 1H 102K-T-A
C298	4510006660	S.ELECTROLYTIC ECEV1HA330P
C299	4030006890	S.CERAMIC C1608 JF 1H 103Z-T-A
C300	4030011600	S.CERAMIC C1608 JB 1C 104KT-N
C301	4510004540	S.ELECTROLYTIC ECEV0JA470SR
C308	4030006900	S.CERAMIC C1608 JB 1E 103K-T-A
C309	4030011600	S.CERAMIC C1608 JB 1C 104KT-N
C312	4030006860	S.CERAMIC C1608 JB 1H 102K-T-A
C313	4030011600	S.CERAMIC C1608 JB 1C 104KT-N
C314	4030011600	S.CERAMIC C1608 JB 1C 104KT-N
C315	4030006900	S.CERAMIC C1608 JB 1E 103K-T-A
C316	4030011180	S.CERAMIC GRM42-6 CH 220J 500PT
C317	4030006900	S.CERAMIC C1608 JB 1E 103K-T-A
C318	4030006900	S.CERAMIC C1608 JB 1E 103K-T-A
C319	4030006900	S.CERAMIC C1608 JB 1E 103K-T-A
C320	4030006900	S.CERAMIC C1608 JB 1E 103K-T-A
C321	4030006860	S.CERAMIC C1608 JB 1H 102K-T-A
C322	4510005630	S.ELECTROLYTIC ECEV1EA330SP
C323	4030006860	S.CERAMIC C1608 JB 1H 102K-T-A
C324	4030006860	S.CERAMIC C1608 JB 1H 102K-T-A
C325	4030011600	S.CERAMIC C1608 JB 1C 104KT-N
C326	4550006560	S.TANTALUM ECST1CY225R
C327	4030006900	S.CERAMIC C1608 JB 1E 103K-T-A
C328	4030006900	S.CERAMIC C1608 JB 1E 103K-T-A
C329	4030006900	S.CERAMIC C1608 JB 1E 103K-T-A
C330	4030011110	S.CERAMIC GRM42-6 CH 090D 500PT
C331	4030011160	S.CERAMIC GRM42-6 CH 150J 500PT
C332	4030006900	S.CERAMIC C1608 JB 1E 103K-T-A
C333	4030006900	S.CERAMIC C1608 JB 1E 103K-T-A
C337	4030011600	S.CERAMIC C1608 JB 1C 104KT-N
C338	4030011600	S.CERAMIC C1608 JB 1C 104KT-N
C339	4030008470	S.CERAMIC C1608 JB 1H 272K-T-A
C340	4030011600	S.CERAMIC C1608 JB 1C 104KT-N
C341	4030006900	S.CERAMIC C1608 JB 1E 103K-T-A
C342	4030006950	S.CERAMIC C1608 CH 1H 040C-T-A
C343	4510006220	S.ELECTROLYTIC ECEV1CA101UP
C344	4030009500	S.CERAMIC C1608 CH 1H 0R5B-T-A
C346	4030006960	S.CERAMIC C1608 CH 1H 050C-T-A
C347	4030011600	S.CERAMIC C1608 JB 1C 104KT-N
C348	4030006900	S.CERAMIC C1608 JB 1E 103K-T-A
C349	4030008650	S.CERAMIC C1608 JB 1H 332K-T-A
C353	4030011600	S.CERAMIC C1608 JB 1C 104KT-N
C354	4030011600	S.CERAMIC C1608 JB 1C 104KT-N
C358	4030007090	S.CERAMIC C1608 CH 1H 470J-T-A
C359	4030007050	S.CERAMIC C1608 CH 1H 220J-T-A
C360	4030006860	S.CERAMIC C1608 JB 1H 102K-T-A
C361	4030006950	S.CERAMIC C1608 CH 1H 040C-T-A
C362	4030006860	S.CERAMIC C1608 JB 1H 102K-T-A
C366	4030006860	S.CERAMIC C1608 JB 1H 102K-T-A
C374	4030006860	S.CERAMIC C1608 JB 1H 102K-T-A
C378	4030006870	S.CERAMIC C1608 JB 1H 222K-T-A
C379	4550006300	S.TANTALUM ECST1AY475R
C380	4550006150	S.TANTALUM ECST1CY105R
C381	4030011600	S.CERAMIC C1608 JB 1C 104KT-N
C382	4030006900	S.CERAMIC C1608 JB 1E 103K-T-A
C383	4550006390	S.TANTALUM TEMSVA 1C 335M-8L
C384	4030011600	S.CERAMIC C1608 JB 1C 104KT-N
C385	4030008900	S.CERAMIC C1608 JB 1C 333K-T-A
C387	4510006670	S.ELECTROLYTIC ECEV1CA471P
C388	4510005750	S.ELECTROLYTIC ECEV1EA220SP
C389	4030006860	S.CERAMIC C1608 JB 1H 102K-T-A
C390	4030011600	S.CERAMIC C1608 JB 1C 104KT-N
C391	4030009500	S.CERAMIC C1608 CH 1H 0R5B-T-A
C392	4030007020	S.CERAMIC C1608 CH 1H 120J-T-A
C395	4030006950	S.CERAMIC C1608 CH 1H 040C-T-A

[MAIN UNIT]

REF NO.	ORDER NO.	DESCRIPTION
C396	4030012610	S.CERAMIC C2012 JB 1C 474K-T-A
C397	4030012610	S.CERAMIC C2012 JB 1C 474K-T-A
C398	4030009000	S.CERAMIC C2012 JB 1C 224K-T-A
C399	4510006220	S.ELECTROLYTIC ECEV1CA101UP
C400	4510004640	S.ELECTROLYTIC ECEV1CA470SP
C401	4510004640	S.ELECTROLYTIC ECEV1CA470SP
C402	4030008980	S.CERAMIC C2012 JB 1C 154K-T-A
C403	4030012600	S.CERAMIC C2012 JB 1A 105M-T-A
C404	4030012610	S.CERAMIC C2012 JB 1C 474K-T-A
C405	4030009350	S.CERAMIC C1608 CH 1H 3R5B-T-A
C406	4030006960	S.CERAMIC C1608 CH 1H 050C-T-A
C407	4030009530	S.CERAMIC C1608 CH 1H 030B-T-A
C409	4030006860	S.CERAMIC C1608 JB 1H 102K-T-A
C410	4030006860	S.CERAMIC C1608 JB 1H 102K-T-A
C413	4550006160	S.TANTALUM ECST1CY155R
C415	4030007060	S.CERAMIC C1608 CH 1H 270J-T-A
C416	4030007030	S.CERAMIC C1608 CH 1H 150J-T-A
C417	4030006860	S.CERAMIC C1608 JB 1H 102K-T-A
C418	4030006860	S.CERAMIC C1608 JB 1H 102K-T-A
C419	4030001170	S.CERAMIC GRM42-6 B 102K 50PT
C420	4030006900	S.CERAMIC C1608 JB 1E 103K-T-A
C421	4030007050	S.CERAMIC C1608 CH 1H 220J-T-A
C422	4030007070	S.CERAMIC C1608 CH 1H 330J-T-A
C423	4030006970	S.CERAMIC C1608 CH 1H 060D-T-A
C424	4030007100	S.CERAMIC C1608 CH 1H 560J-T-A
C425	4030006900	S.CERAMIC C1608 JB 1E 103K-T-A
C426	4030009990	S.CERAMIC C1608 CH 1H 200J-T-A
C427	4030007080	S.CERAMIC C1608 CH 1H 390J-T-A
C428	4030006900	S.CERAMIC C1608 JB 1E 103K-T-A
C429	4030009550	S.CERAMIC C1608 CH 1H 2R5B-T-A
C430	4030006900	S.CERAMIC C1608 JB 1E 103K-T-A
C431	4510006220	S.ELECTROLYTIC ECEV1CA101UP
C433	4510004650	S.ELECTROLYTIC ECEV1EA4R7SR
C434	4030006960	S.CERAMIC C1608 CH 1H 050C-T-A
C436	4510004630	S.ELECTROLYTIC ECEV1CA100SR
C437	4510004630	S.ELECTROLYTIC ECEV1CA100SR
C438	4030006900	S.CERAMIC C1608 JB 1E 103K-T-A
C439	4030007170	S.CERAMIC C1608 CH 1H 221J-T-A
C441	4510006220	S.ELECTROLYTIC ECEV1CA101UP
C442	4030006900	S.CERAMIC C1608 JB 1E 103K-T-A
C443	4030011600	S.CERAMIC C1608 JB 1C 104KT-N
C444	4030006900	S.CERAMIC C1608 JB 1E 103K-T-A
C445	4510006220	S.ELECTROLYTIC ECEV1CA101UP
C446	4030010760	S.CERAMIC C1608 CH 1H 331J-T-A
C447	4030012600	S.CERAMIC C2012 JB 1A 105M-T-A
C448	4510006220	S.ELECTROLYTIC ECEV1CA101UP
C449	4030006900	S.CERAMIC C1608 JB 1E 103K-T-A
C450	4030007120	S.CERAMIC C1608 CH 1H 820J-T-A
C451	4030010040	S.CERAMIC C1608 JB 1H 561K-T-A
C452	4510007230	ELECTROLYTIC 50 YXG 1000UF
C453	4510005870	S.ELECTROLYTIC ECEV1HA3R3SR
C454	4550003210	S.TANTALUM TEMSDV2 1D 226M-12R
C455	4030006900	S.CERAMIC C1608 JB 1E 103K-T-A
C456	4030017070	S.CERAMIC GRM42-2 R 474K 50PT
C457	4030017070	S.CERAMIC GRM42-2 R 474K 50PT
C462	4030017070	S.CERAMIC GRM42-2 R 474K 50PT
C463	4030017070	S.CERAMIC GRM42-2 R 474K 50PT
C468	4030017070	S.CERAMIC GRM42-2 R 474K 50PT
C472	4030006860	S.CERAMIC C1608 JB 1H 102K-T-A
C500	4030009650	S.CERAMIC C1608 CH 1H 240J-T-A
C501	4030007050	S.CERAMIC C1608 CH 1H 220J-T-A
C502	4030007110	S.CERAMIC C1608 CH 1H 680J-T-A
C503	4030006980	S.CERAMIC C1608 CH 1H 070D-T-A
C504	4030007150	S.CERAMIC C1608 CH 1H 151J-T-A
C505	4510007320	ELECTROLYTIC 50 YXG 470M
C506	4510004420	S.ELECTROLYTIC ECEV0JV330SR
C507	4030008960	S.CERAMIC C2012 JB 1C 104K-T-A
C508	4030010020	S.CERAMIC C1608 JB 1H 122K-T-A
C509	4030010020	S.CERAMIC C1608 JB 1H 122K-T-A
C512	4030006860	S.CERAMIC C1608 JB 1H 102K-T-A
C513	4510004630	S.ELECTROLYTIC ECEV1CA100SR
C514	4030006860	S.CERAMIC C1608 JB 1H 102K-T-A
C515	4030006860	S.CERAMIC C1608 JB 1H 102K-T-A
C516	4030011600	S.CERAMIC C1608 JB 1C 104KT-N
C517	4030006860	S.CERAMIC C1608 JB 1H 102K-T-A
C518	4030016990	S.CERAMIC GRM42-2 R 105K 50PT
C519	4030017190	S.CERAMIC GHM1030 R 471K 630PT
C520	4030011280	S.CERAMIC C1608 CH 1H 271J-T-A
C521	4510004650	S.ELECTROLYTIC ECEV1EA4R7SR
C522	4510005860	S.ELECTROLYTIC ECEV1HA2R2SR
C522	4030007050	S.CERAMIC C1608 CH 1H 220J-T-A

Ⓐ: [A110EURO], Ⓑ: [USA-1] and [A110EURO], Ⓒ: [A110],
 Ⓓ: [GEN-1] and [AUS]

S.=Surface mount

[MAIN UNIT]

REF NO.	ORDER NO.	DESCRIPTION		
C523	4030006870	S.CERAMIC	C1608 JB 1H 222K-T-A	
C524	4030008550	S.CERAMIC	C2012 JF 1H 473Z-T-A	
C525	4030006860	S.CERAMIC	C1608 JB 1H 102K-T-A	
C529	4030008920	S.CERAMIC	C1608 JB 1C 473K-T-A	
C530	4030008770	S.CERAMIC	C1608 JB 1H 562K-T-A	
C531	4510007390	ELECTROLYTIC	50 YK 220M	
C533	4030009530	S.CERAMIC	C1608 CH 1H 030B-T-A	
C535	4510005520	ELECTROLYTIC	50 MV 330 HC	
C536	4030011600	S.CERAMIC	C1608 JB 1C 104KT-N	
C537	4030006860	S.CERAMIC	C1608 JB 1H 102K-T-A	
C538	4030007140	S.CERAMIC	C1608 CH 1H 121J-T-A	Ⓒ
	4030009650	S.CERAMIC	C1608 CH 1H 240J-T-A	Ⓐ
C539	4030007010	S.CERAMIC	C1608 CH 1H 100D-T-A	Ⓒ
	4030007030	S.CERAMIC	C1608 CH 1H 150J-T-A	Ⓐ
	4030006860	S.CERAMIC	C1608 JB 1H 102K-T-A	
C541	4030011600	S.CERAMIC	C1608 JB 1C 104KT-N	
C542	4030011600	S.CERAMIC	C1608 JB 1C 104KT-N	
C543	4030011600	S.CERAMIC	C1608 JB 1C 104KT-N	
C544	4030007150	S.CERAMIC	C1608 CH 1H 151J-T-A	
C545	4030007020	S.CERAMIC	C1608 CH 1H 120J-T-A	
C546	4030007000	S.CERAMIC	C1608 CH 1H 090D-T-A	
C547	4030009650	S.CERAMIC	C1608 CH 1H 240J-T-A	
C548	4030006860	S.CERAMIC	C1608 JB 1H 102K-T-A	
C549	4030016990	S.CERAMIC	GRM42-2 R 105K 50PT	
C550	4030006860	S.CERAMIC	C1608 JB 1H 102K-T-A	
C551	4030007090	S.CERAMIC	C1608 CH 1H 470J-T-A	
C552	4030009530	S.CERAMIC	C1608 CH 1H 030B-T-A	
C553	4550006540	S.TANTALUM	ECST1CY475R	
C554	4030017190	S.CERAMIC	GHM1030 R 471K 630PT	
C555	4030009650	S.CERAMIC	C1608 CH 1H 240J-T-A	
C556	4030009650	S.CERAMIC	C1608 CH 1H 240J-T-A	
C557	4030004750	S.CERAMIC	C2012 JB 1H 103K-T-A	
C558	4030006860	S.CERAMIC	C1608 JB 1H 102K-T-A	
C559	4030007070	S.CERAMIC	C1608 CH 1H 330J-T-A	Ⓐ only
C560	4030006850	S.CERAMIC	C1608 JB 1H 471K-T-A	Ⓐ only
C561	4030006860	S.CERAMIC	C1608 JB 1H 102K-T-A	Ⓐ only
C562	4030007070	S.CERAMIC	C1608 CH 1H 330J-T-A	Ⓐ only
C563	4030006850	S.CERAMIC	C1608 JB 1H 471K-T-A	Ⓐ only
C564	4030006860	S.CERAMIC	C1608 JB 1H 102K-T-A	Ⓐ only
C565	4030007070	S.CERAMIC	C1608 CH 1H 330J-T-A	Ⓐ only
C566	4030006850	S.CERAMIC	C1608 JB 1H 471K-T-A	Ⓐ only
C567	4030006860	S.CERAMIC	C1608 JB 1H 102K-T-A	Ⓐ only
C568	4030006850	S.CERAMIC	C1608 JB 1H 471K-T-A	Ⓐ only
C569	4030004720	S.CERAMIC	C2012 JB 1H 102K-T-A	Ⓐ only
C570	4030004710	S.CERAMIC	C2012 JB 1H 471K-T-A	Ⓐ only
C571	4030005030	S.CERAMIC	C2012 CH 1H 221J-T-A	Ⓐ only
C572	4030007170	S.CERAMIC	C1608 CH 1H 221J-T-A	Ⓐ only
C573	4030007130	S.CERAMIC	C1608 CH 1H 101J-T-A	Ⓐ only
C574	4030007090	S.CERAMIC	C1608 CH 1H 470J-T-A	Ⓐ only
C575	4030017070	S.CERAMIC	GRM42-2 R 474K 50PT	
C576	4030006860	S.CERAMIC	C1608 JB 1H 102K-T-A	Ⓐ only
C577	4030006860	S.CERAMIC	C1608 JB 1H 102K-T-A	Ⓐ only
J5	6510020510	S.CONNECTOR	FH12-40S-0.5SV	
J6	6510009400	CONNECTOR	B7B-ZR	
J7	6450000140	CONNECTOR	HSJ0807-01-010	
T1	5920000750	TRANSFORMER	ST-82 (P)	
W1	8900009210	CABLE	OPC-905	
W2	7120000470	JUMPER	ERDS2T0	
W3	7120000470	JUMPER	ERDS2T0	
W4	7120000470	JUMPER	ERDS2T0	
W15	7030003860	S.JUMPER	ERJ3GE JPW V	
W25	7030003860	S.JUMPER	ERJ3GE JPW V	Ⓓ only
W27	7030003860	S.JUMPER	ERJ3GE JPW V	
W28	7030003860	S.JUMPER	ERJ3GE JPW V	Ⓓ only
W29	7030007150	S.JUMPER	MCR50JZHJ JPW (000)	Ⓒ only
W32	7030003860	S.JUMPER	ERJ3GE JPW V	
W33	7030003860	S.JUMPER	ERJ3GE JPW V	
W34	7030003970	S.JUMPER	MCR18EZHZ JPW	
W35	7030007150	S.JUMPER	MCR50JZHJ JPW (000)	
W38	7030000010	S.JUMPER	MCR10EZHZ JPW (000)	Ⓓ only
W39	7030003970	S.JUMPER	MCR18EZHZ JPW	
W40	7030003970	S.JUMPER	MCR18EZHZ JPW	
W41	7030003860	S.JUMPER	ERJ3GE JPW V	

[MAIN UNIT]

REF NO.	ORDER NO.	DESCRIPTION		
W42	7030003860	S.JUMPER	ERJ3GE JPW V	
W43	7030003860	S.JUMPER	ERJ3GE JPW V	
W44	7030003860	S.JUMPER	ERJ3GE JPW V	
W46	7030003860	S.JUMPER	ERJ3GE JPW V	Ⓒ only
W47	7030000010	S.JUMPER	MCR10EZHZ JPW (000)	
W48	7030003970	S.JUMPER	MCR18EZHZ JPW	
W49	7030007150	S.JUMPER	MCR50JZHJ JPW (000)	Ⓒ only
W51	7030003860	S.JUMPER	ERJ3GE JPW V	
W52	7030003970	S.JUMPER	MCR18EZHZ JPW	Ⓐ only
W53	7030003970	S.JUMPER	MCR18EZHZ JPW	Ⓐ only
W54	7030003970	S.JUMPER	MCR18EZHZ JPW	Ⓐ only
W71	7030003860	S.JUMPER	ERJ3GE JPW V	Ⓒ only
WS1	8970023550	E.OTHER	AX2270 J LEAD SET (2) /MA	
EP1	0910051547	PCB	B 5318G	Ⓒ
	0910053661	PCB	B 5531A	Ⓐ
EP2	6910013270	BEAD	2643-625002	
EP3	9040901901	TUBE	IRRAX 0.7 (d) L=12 mm	
EP4	9040901901	TUBE	IRRAX 0.7 (d) L=12 mm	
EP5	6910010220	BEAD	HF70BB3.5X5X1.3	Ⓐ only

Ⓐ: [A110EURO], Ⓑ: [USA-1] and [A110EURO], Ⓒ: [A110],
 Ⓓ: [GEN-1] and [AUS]

S.=Surface mount

SECTION 6

MECHANICAL PARTS AND DISSASSEMBLY

[CHASSIS PARTS]

REF. NO	ORDER NO.	DESCRIPTION	QTY.
J1	6510004880	Connector MR-DS-E 01	1
MP1	8010017872	2270 chassis-2 42-324	1
MP2	8810008660	Screw PH BT M3 X 8 NI-ZU	8
MP3	8810008490	Setscrew H M2.6 X 8 NI	2
MP4	8810008660	Screw PH BT M3 X 8 NI-ZU	2
MP5	8810009130	Screw PH BT M3 X12 NI-ZU	4
MP6	8930050080	2270 IC clip	1
MP7	8820000870	1705 cap screw	3
MP8	8110006941	1705 cover (B)-1 43-224	1
MP9	8930049650	Thermal sheet (H)	1
MP10	8930036771	1705 main seal-1	1
MP11	8930050130	2270 jack sheet	1
MP12	8310027320	Display seal (U) [USA/-1] only	1
MP13	8930051440	2270 thermal sheet TC-200TKC	1
MP18	8930051830	2270 B-sheet	1
MP19	8930051820	2270 A-sponge	1
MP20	8930052930	Theraml sheet (P) (TC-500TK)	1

[MAIN UNIT]

REF. NO	ORDER NO.	DESCRIPTION	QTY.
J7	6450000140	Connector HSJ0807-01-010	1
W1	8900009210	Cable OPC-905	1
MP1	8510011660	2088 VCO case	1
MP2	8930013590	Alumi sheet N	1
MP3	8510013920	2270 IF shield	1
MP4	8510012950	2270 A-shield plate	1
MP5	8510012920	2270 B-shield plate	1
MP6	8510012910	2270 rug	1
MP7	8930051860	2270 A-sheet	1
MP8	8510012960	2270 C-shield plate	1
MP9	8950000180	Cable tie -80	1
MP13	8510013330	2270 S-case [A110EURO] only	1
MP14	8510013320	2270 S-cover [A110EURO] only	1
MP15	8930001810	Sponge (A) [A110EURO] only	1
MP16	8510005530	VCO shield plate (B) SX644 [A110EURO] only	1
MP17	8930049620	Ferrite sheet (H) [A110EURO] only	1
MP18	8930054360	2270 sheet [A110EURO] only	1

[FRONT UNIT]

REF. NO	ORDER NO.	DESCRIPTION	QTY.
J2	6450001470	Connector 95003-2881	1
DS1	5030001740	LCD HLC7453-012400	1
EP2	8930037960	LCD contact SRCN-1705 ZSS	1
SP1	2510000880	Speaker SME-45W	1
MP1	8210012610	1705 reflector	1
MP2	8930036830	1705 LCD holder	1
MP3	8930036820	1705 LCD filter	1
MP4	8930037660	1705 LCD sheet	1
MP6	8210012600	1705 front panel assembly	1
MP7	8930049760	1705 front key (C)	1
MP8	8610009840	Knob N234	1
MP10	8810009130	Screw PH B0 M3 X 12 NI-ZU	3
MP14	8930053500	2270 earth plate [A110EURO] only	1
MP15	8930055320	2270 A-earth plate [A110EURO] only	1

[ACCESSORIES]

REF. NO	ORDER NO.	DESCRIPTION	QTY.
F1	5210000070	Fuse FGB 10A	2
W1	8900003741	DC power cable OPC-344 [A110]	1
	8900010730	DC power cable OPC-1091 [A110EURO]	1
W2	8900000730	Microphone (HANG) cable OPC-049	1
MC1	0800005780	Microphone HM-100N	1
MP1	8010016730	150 mounting bracket	1
MP3	8820000530	Flange bolt M4 X 8 NI	4
MP4	8810000470	Screw PH M5 X 12 (+/-)	4
MP5	8810005840	Screw PH A0 M5 X 20	4
MP6	8850000150	Flat washer M5 NI BS	4
MP7	8850000390	Spring washer M5	4
MP8	8830000120	Nut M5	4
MP9	6910004210	731 microphone hanger set (incl. 2 screws, 2 washers)	1

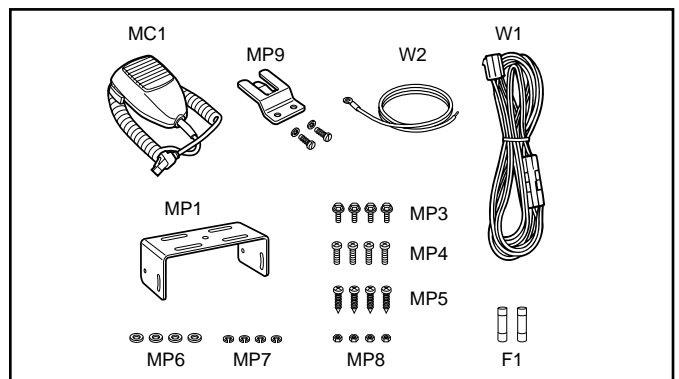





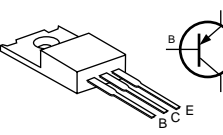
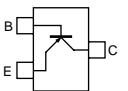
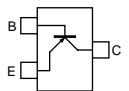
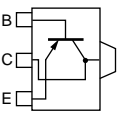
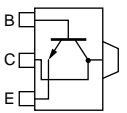
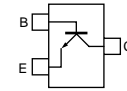
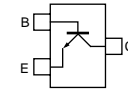
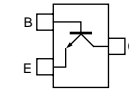
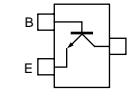
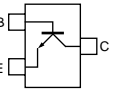
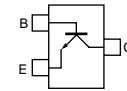
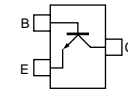
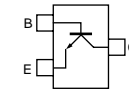
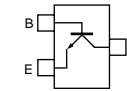
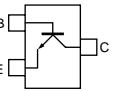
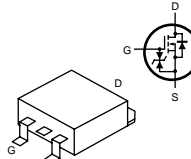
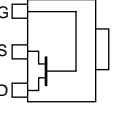
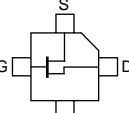
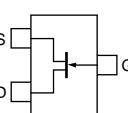
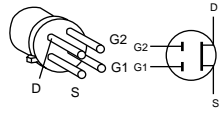
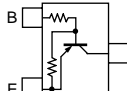
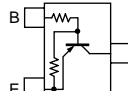
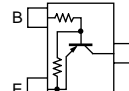
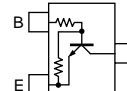
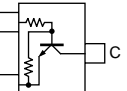
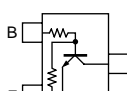
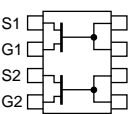
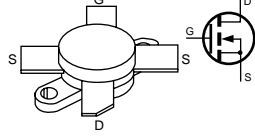
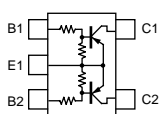
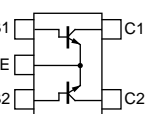
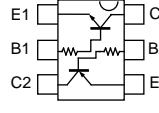

Screw abbreviations A0,B0,BT: Self-tapping
 PH: Pan head NI: Nickel
 NI-ZU: Nickel-Zinc

SECTION 7 SEMI-CONDUCTOR INFORMATION

• TRANSISTORS AND FET'S

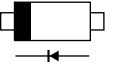
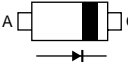
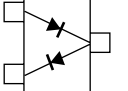
2SA1471R 	2SA1586 GR (Symbol: SG) 	2SA1622 6 TL (Symbol: M6) 	2SB1132 T100 R (Symbol: BART) 	2SB798 T2 DK (Symbol: DK) 
2SC4081 T107 R (Symbol: BR) 	2SC4081 T107 S (Symbol: BS) 	2SC4116 BL (Symbol: LL) 	2SC4211-6-TL (Symbol: L6) 	2SC4215 O (Symbol: QO) 
2SC4215 Y (Symbol: QY) 	2SC4226 T2 R25 (Symbol: R25) 	2SC4228(M)-T1 R45 (Symbol: R45) 	2SC4403 3 TL (Symbol: LY3) 	2SD1819 A R (Symbol: LG) 
2SK2414-Z-E1 	2SK3074 (Symbol: UW) 	2SK3075 (Symbol: UB F) 	2SK880 GR (Symbol: XG) 	3SK184 R (Symbol: 3R R) 
DTA143ZUA T106 (Symbol: 113) 	DTA144EUA T106 (Symbol: 16) 	DTB123 EK T147 (Symbol: F12) 	DTC114EUA T106 (Symbol: 24) 	DTC144 EE TL (Symbol: 26) 
DTC144EUA T106 (Symbol: 26) 	FW215-TL (Symbol: W215) 	MRF137 (Symbol: MRF133) 	XP1113 (Symbol: 7L) 	XP1501 AB (Symbol: 5R) 
XP4315 (Symbol: CB) 				

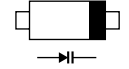
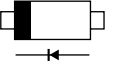
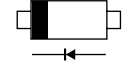
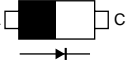
• DIODES

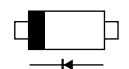
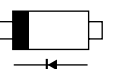
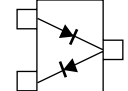
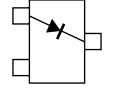
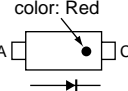
1SS193 (Symbol: F3) 	1SS352 (Symbol: C1) 	1SV271 (Symbol: TG) 	1SV307 (Symbol: TX) 	DA204 U T107 (Symbol: K) 
DE5SC6M-4061 (Symbol: 5SC6) 	HVU350B TRF (Symbol: BO) 	MA111 (Symbol: 1B) 	MA2S111 (Symbol: A) 	MA77 (Symbol: 4B) 
MA8036 L (Symbol: 3_6) 	MA8051 M (Symbol: 5-1) 	MA8330 M (Symbol: 33-) 	RB706F-40 T106 (Symbol: 3J) 	SB07-03C-TB (Symbol: J) 
MA4PH224 color: Red 				

SECTION 8 BOARD LAYOUTS

8-1 FRONT UNIT (IC-A110)

• TOP VIEW

The combination of this page and the next page show the unit layout in the same configuration as the actual P.C.Board.

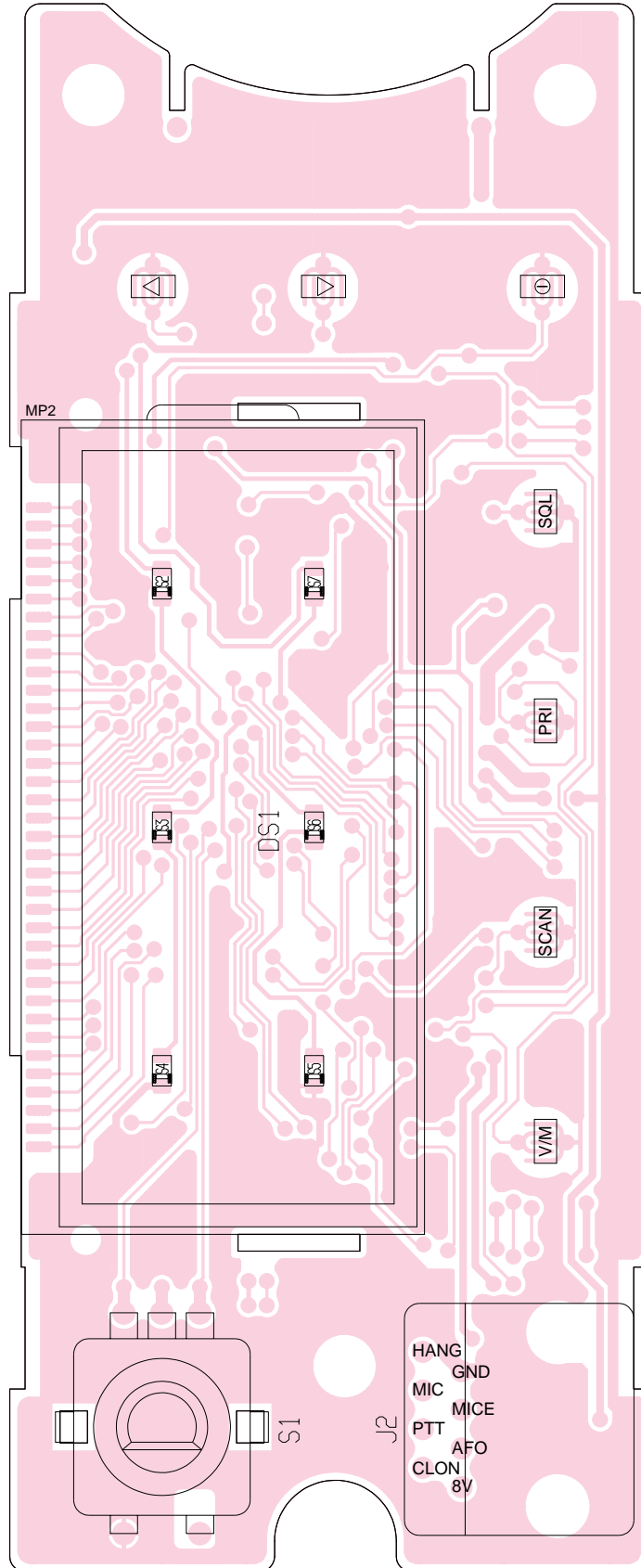

● BOTTOM VIEW

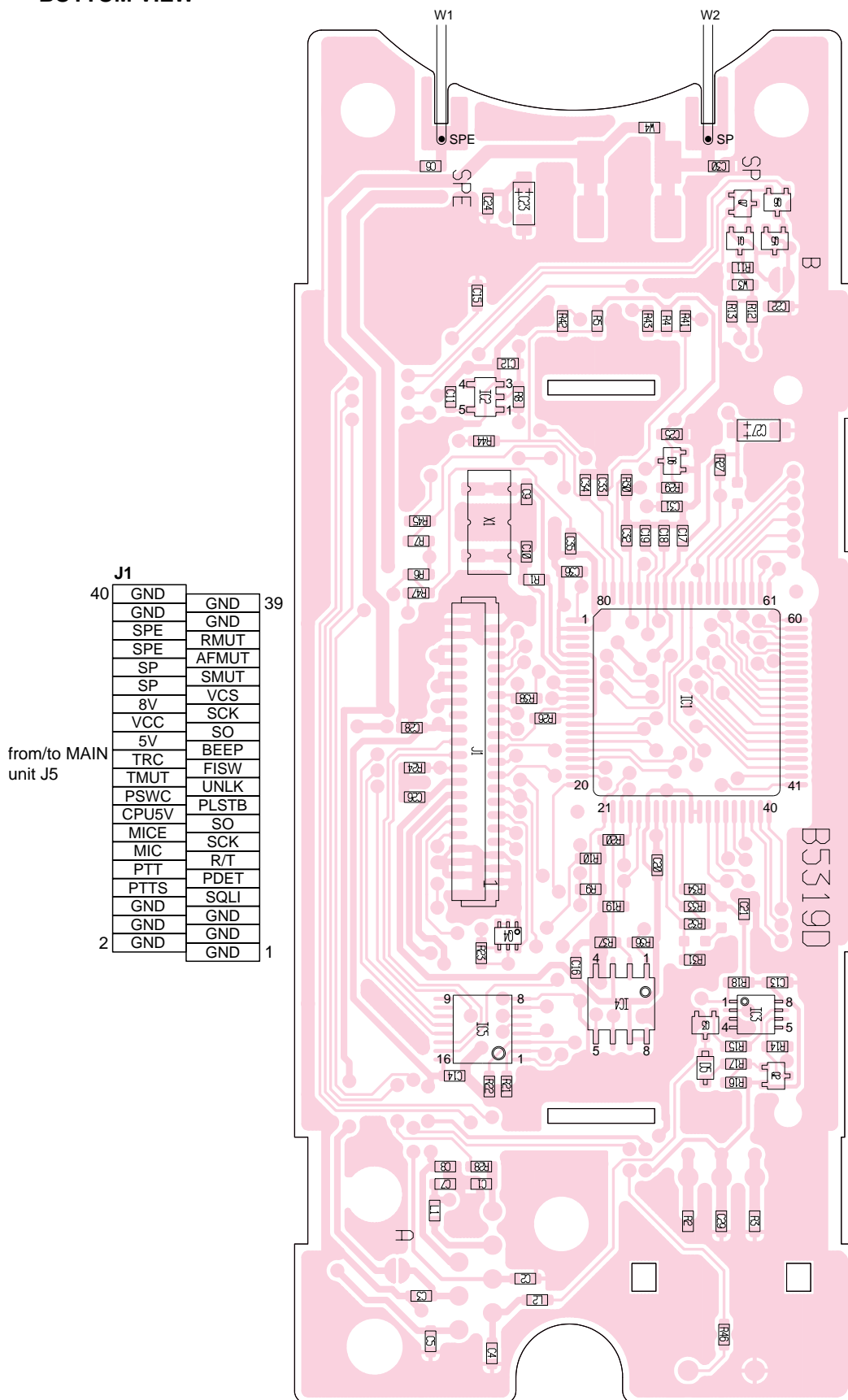

8-2 MAIN UNIT (IC-A110)

● TOP VIEW

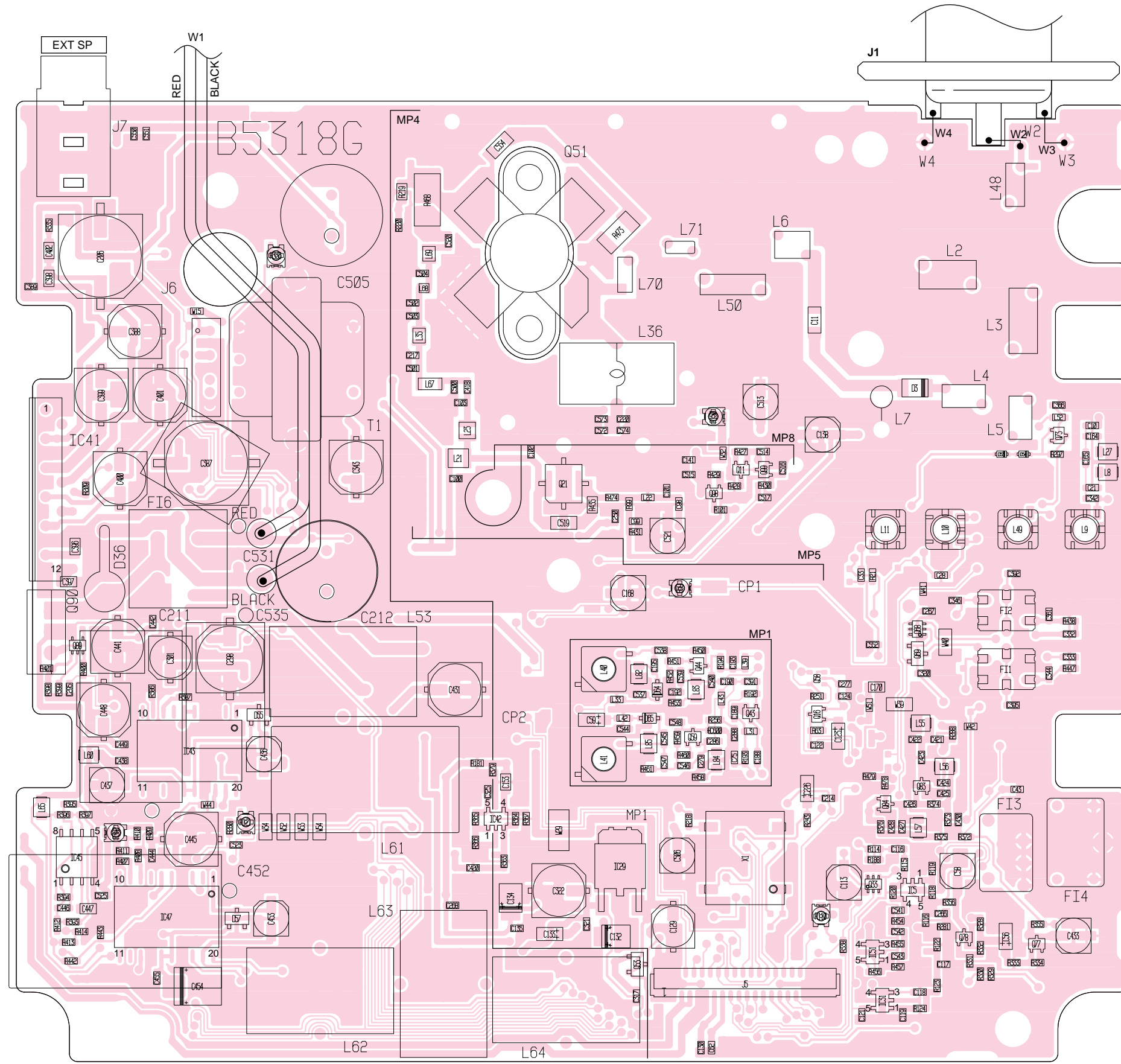

The combination of this page and the next page show the unit layout in the same configuration as the actual P.C.Board.

2	GND	GND	RMUT	AFMUT	SP	SMUT	VCS	SCK	SO	BEEP	FISW	UNLK	PLSTB	SO	SCK	R/T	NC	SOL1	GND	GND	GND	40
J5	GND	GND	SPE	SPE	SP	SP	8V	VCC	5V	TRC	TMUT	PSWC	CPU5V	MICE	MIC	PTT	PTTS	GND	GND	GND	1	
	from/to FRONT unit J1																					
1																						39

● BOTTOM VIEW

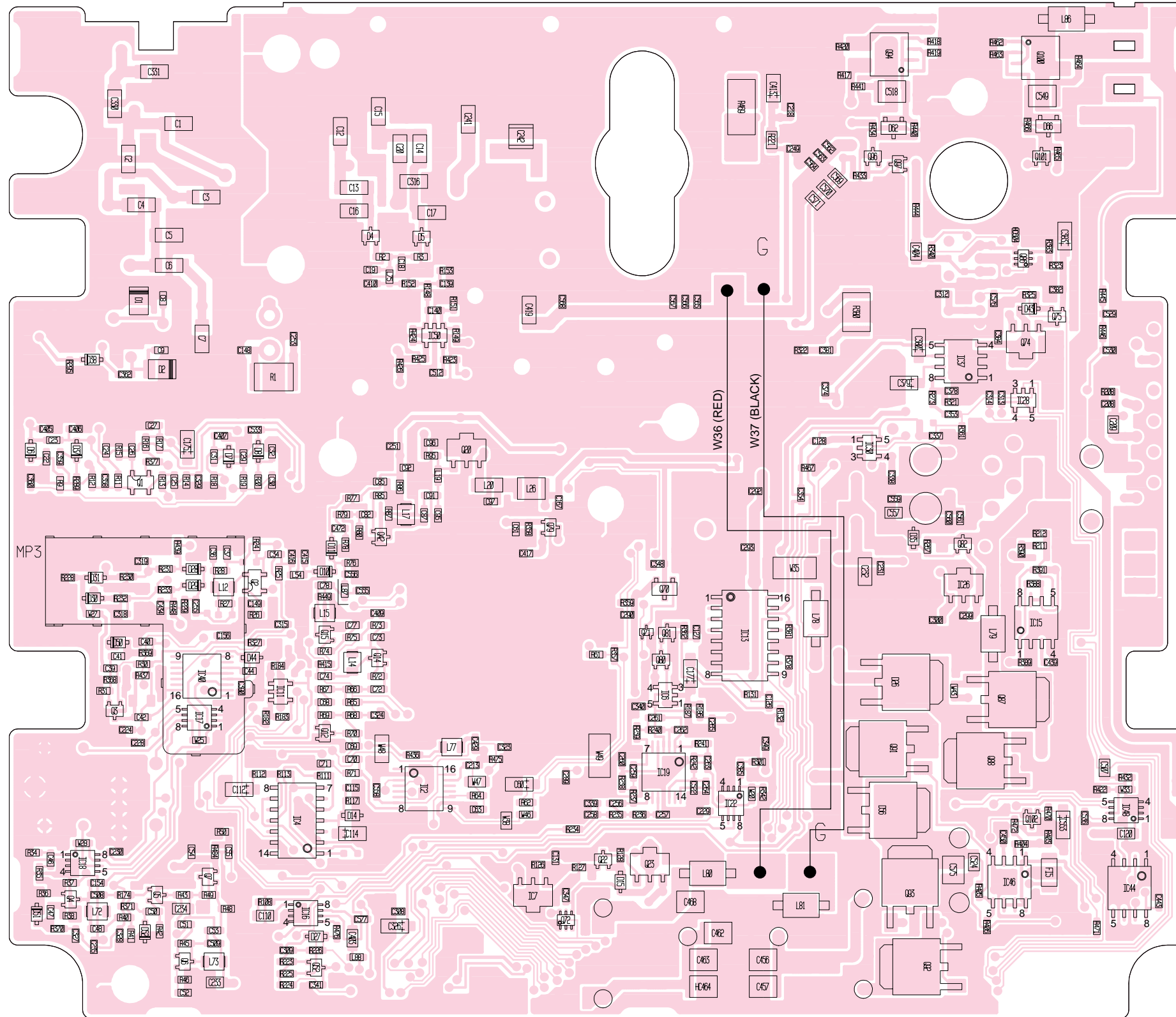

8-3 FRONT UNIT (IC-A110EURO)

• TOP VIEW

The combination of this page and the next page show the unit layout in the same configuration as the actual P.C.Board.

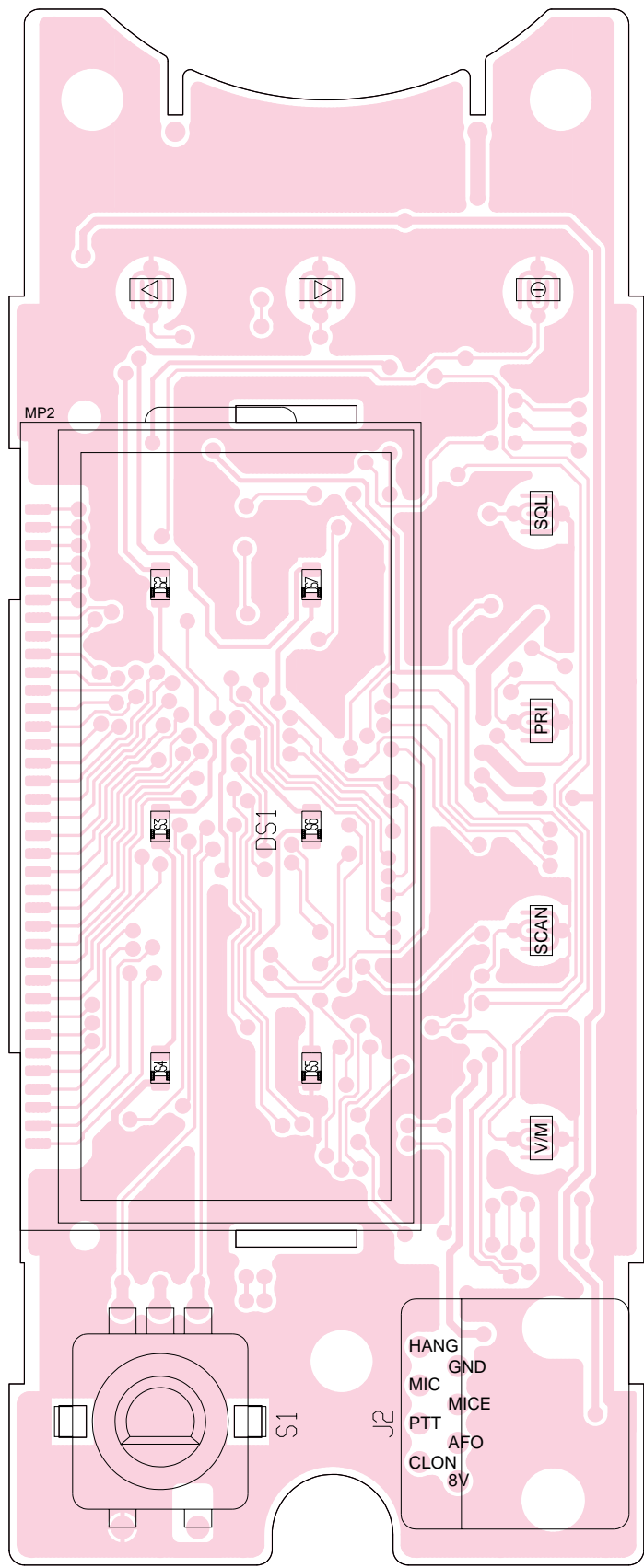

● BOTTOM VIEW

40		J1		39	
	GND		GND		
	GND		GND		
	SPE		RMUT		
	SPE		AFMUT		
	SP		SMUT		
	SP		VCS		
	8V		SCK		
	VCC		SO		
	5V		BEEP		
	TRC		FISW		
	TMUT		UNLK		
	PSWC		PLSTB		
	CPU5V		SO		
	MICE		SCK		
	MIC		R/T		
	PTT		PDET		
	PTTS		SQLI		
	GND		GND		
	GND		GND		
2	GND		GND		1

from/to MAIN unit J5

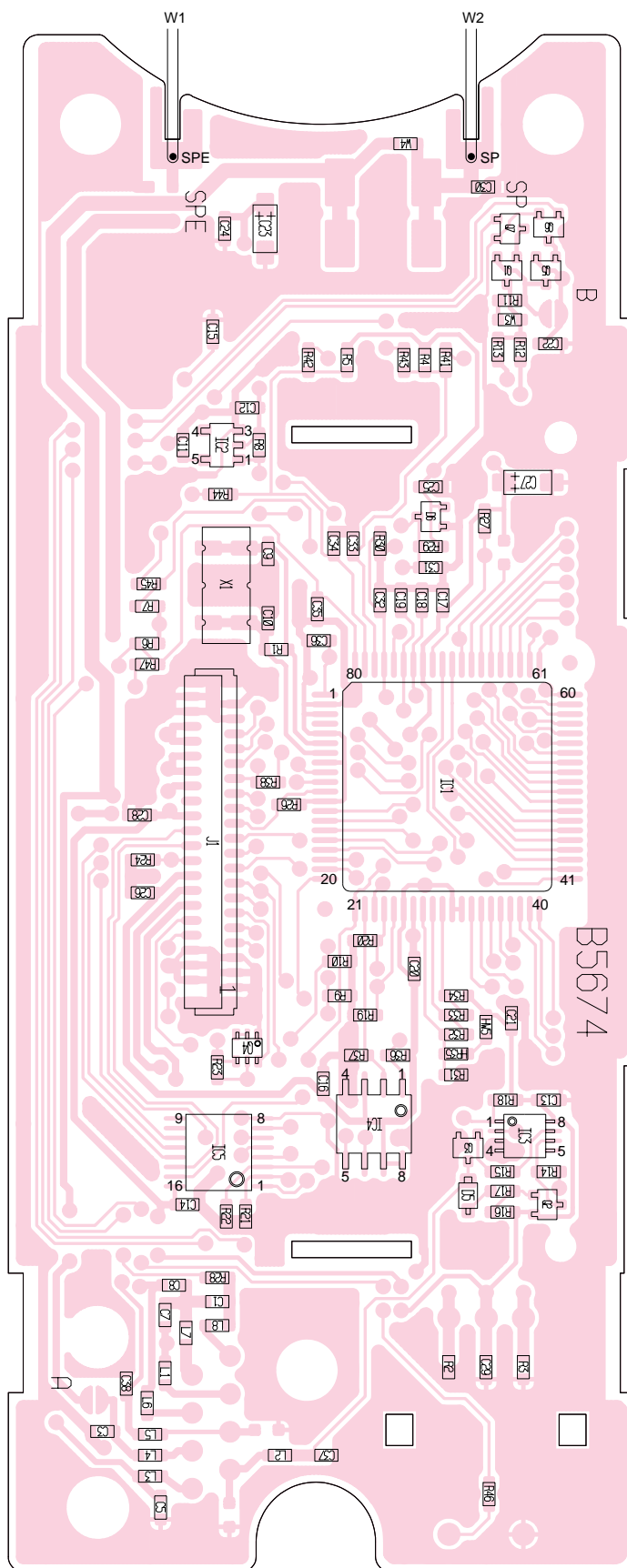

8-4 MAIN UNIT (IC-A110EURO)

● TOP VIEW

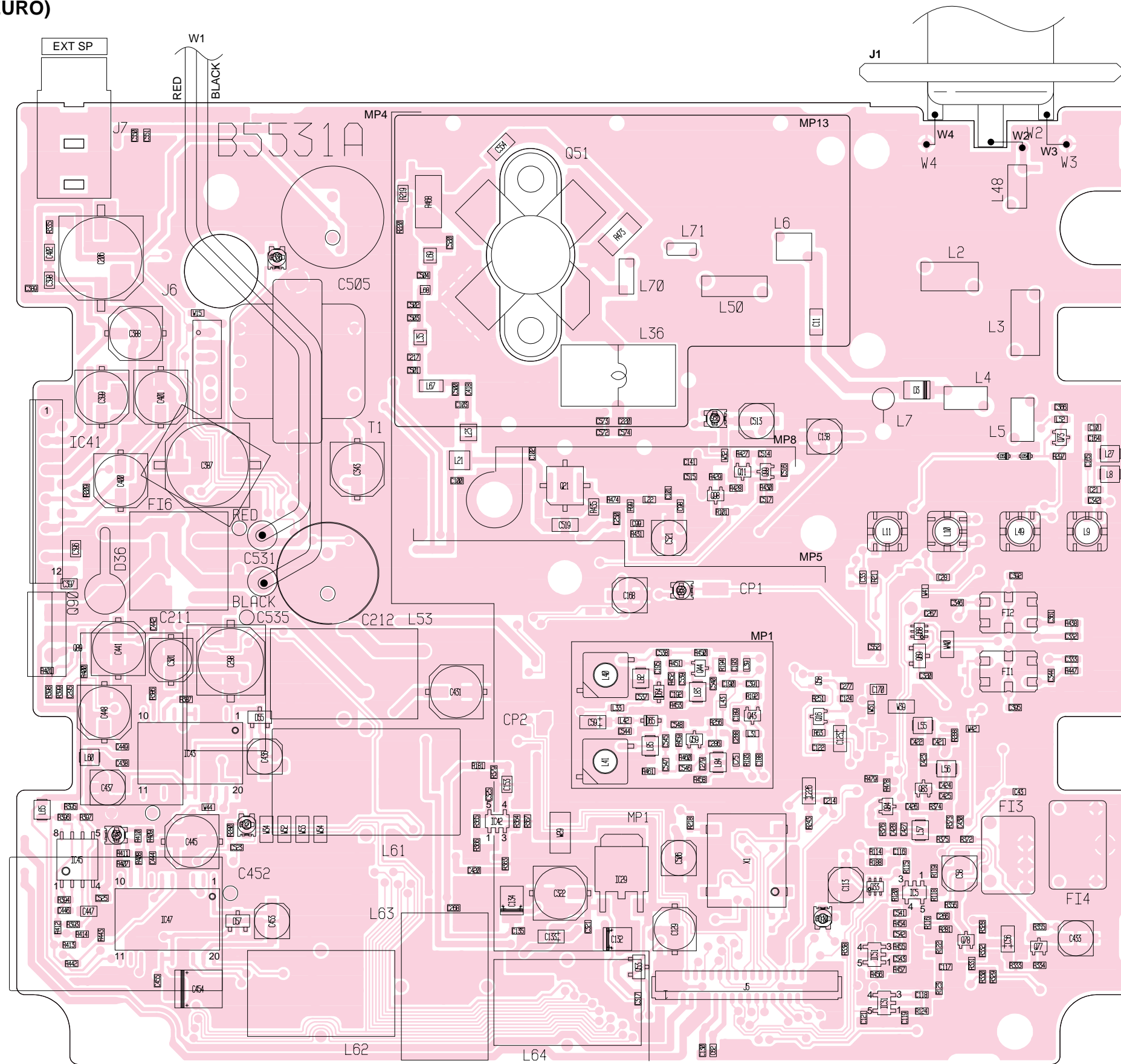

The combination of this page and the next page show the unit layout in the same configuration as the actual P.C.Board.

2	GND	40
J5	GND	
	SPE	
	SPE	
	SP	
	SP	
	8V	
	VCC	
	5V	
	TRC	
	FISW	
	TMUT	
	PSWC	
	CPU5V	
	MICE	
	MIC	
	PTT	
	PTTS	
	GND	
	GND	
	GND	
1		39

from/to FRONT unit J1

● BOTTOM VIEW

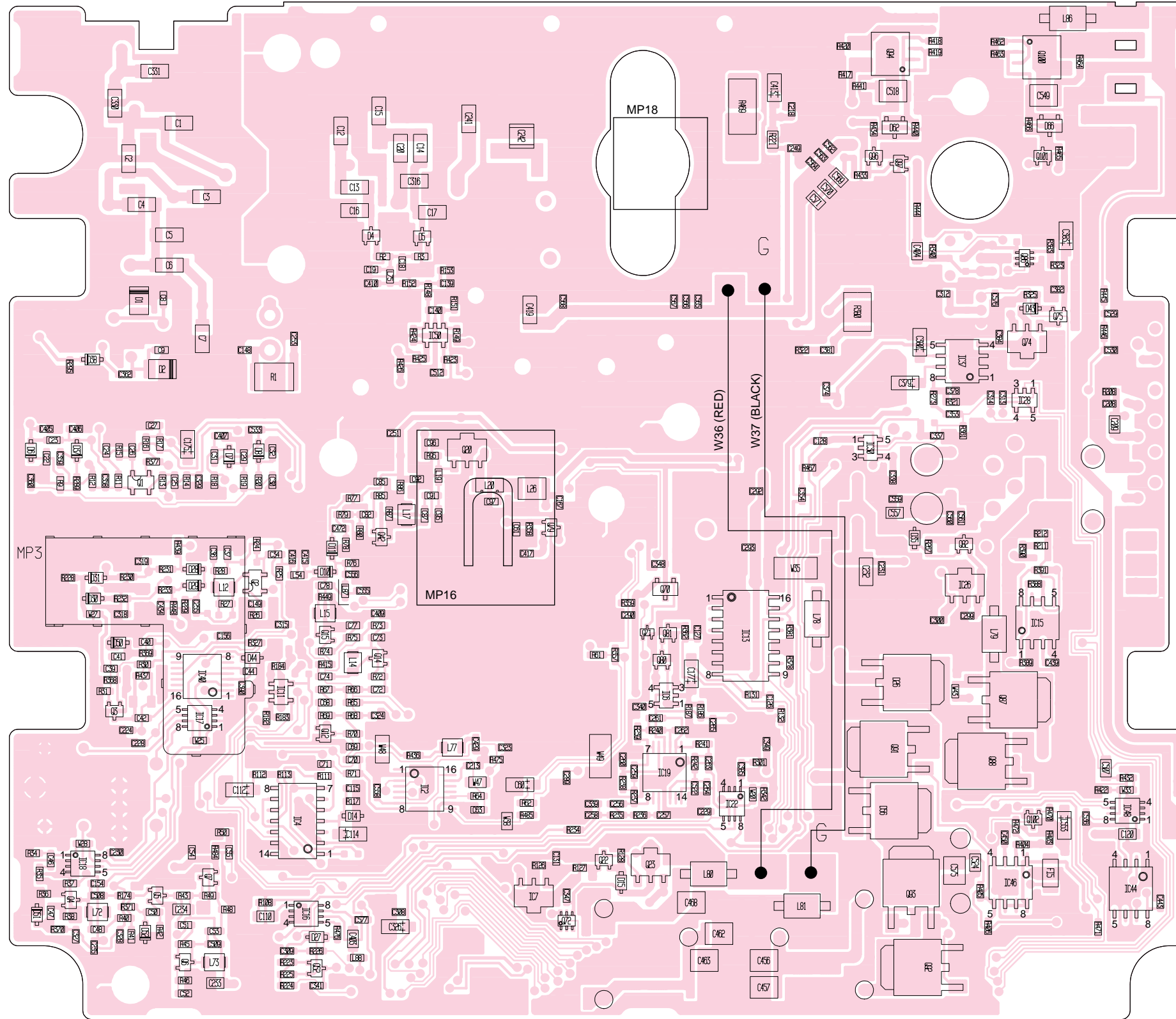

SECTION 9 BLOCK DIAGRAM

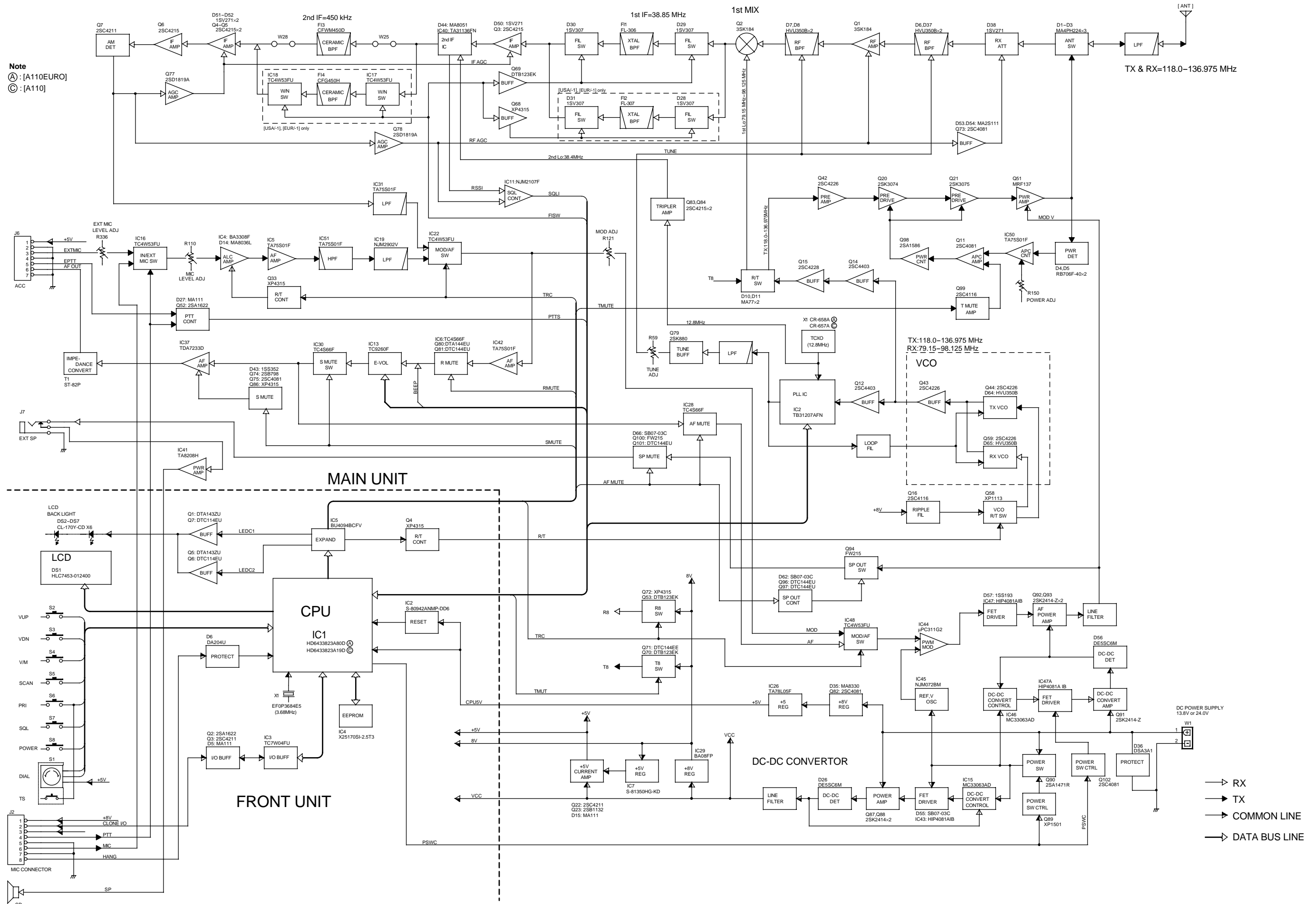

10-2 MAIN UNIT

Note
 (A): [A110EURO]
 (B): [USA-1], [A110EURO]
 (C): [A110]

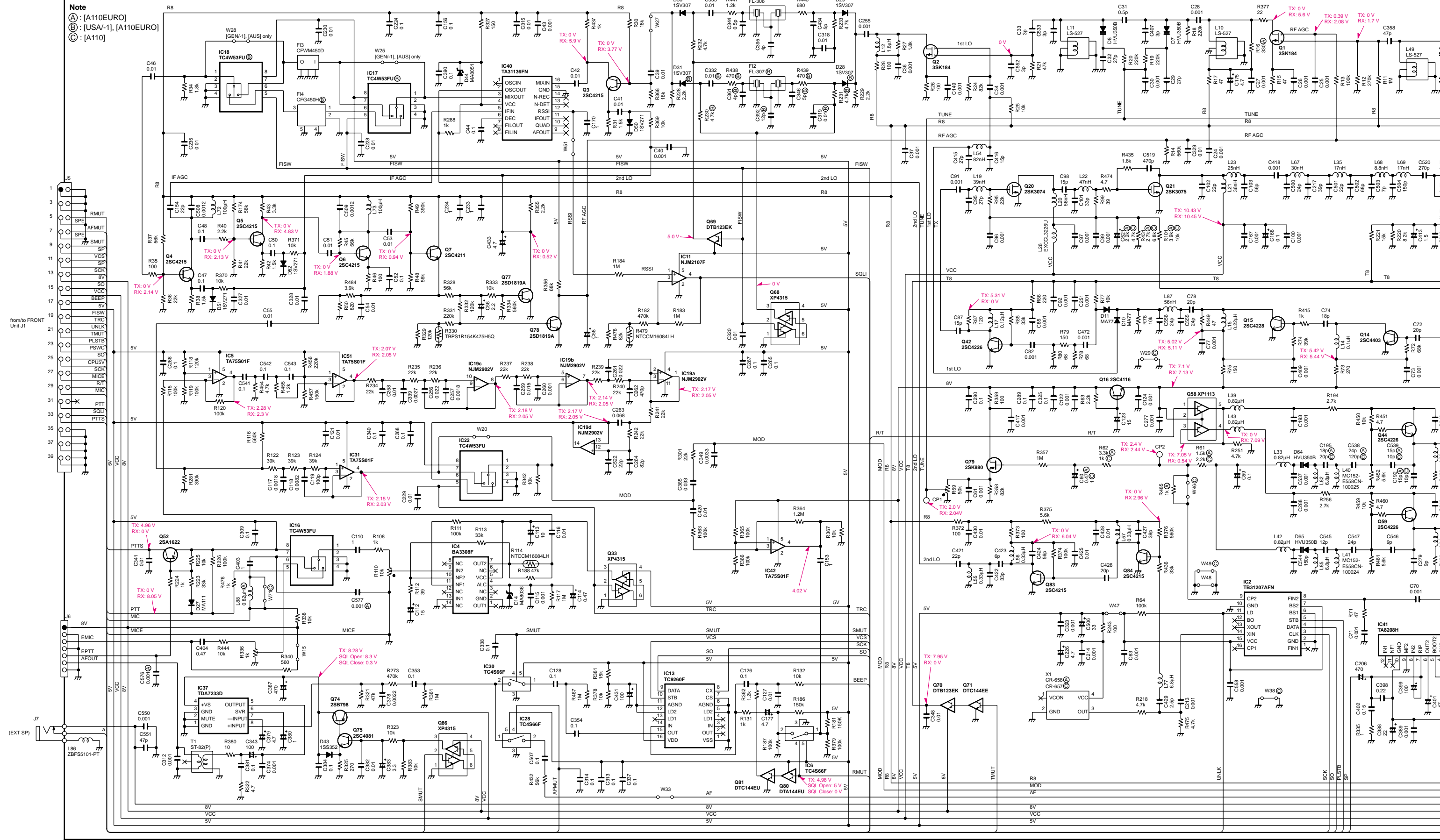

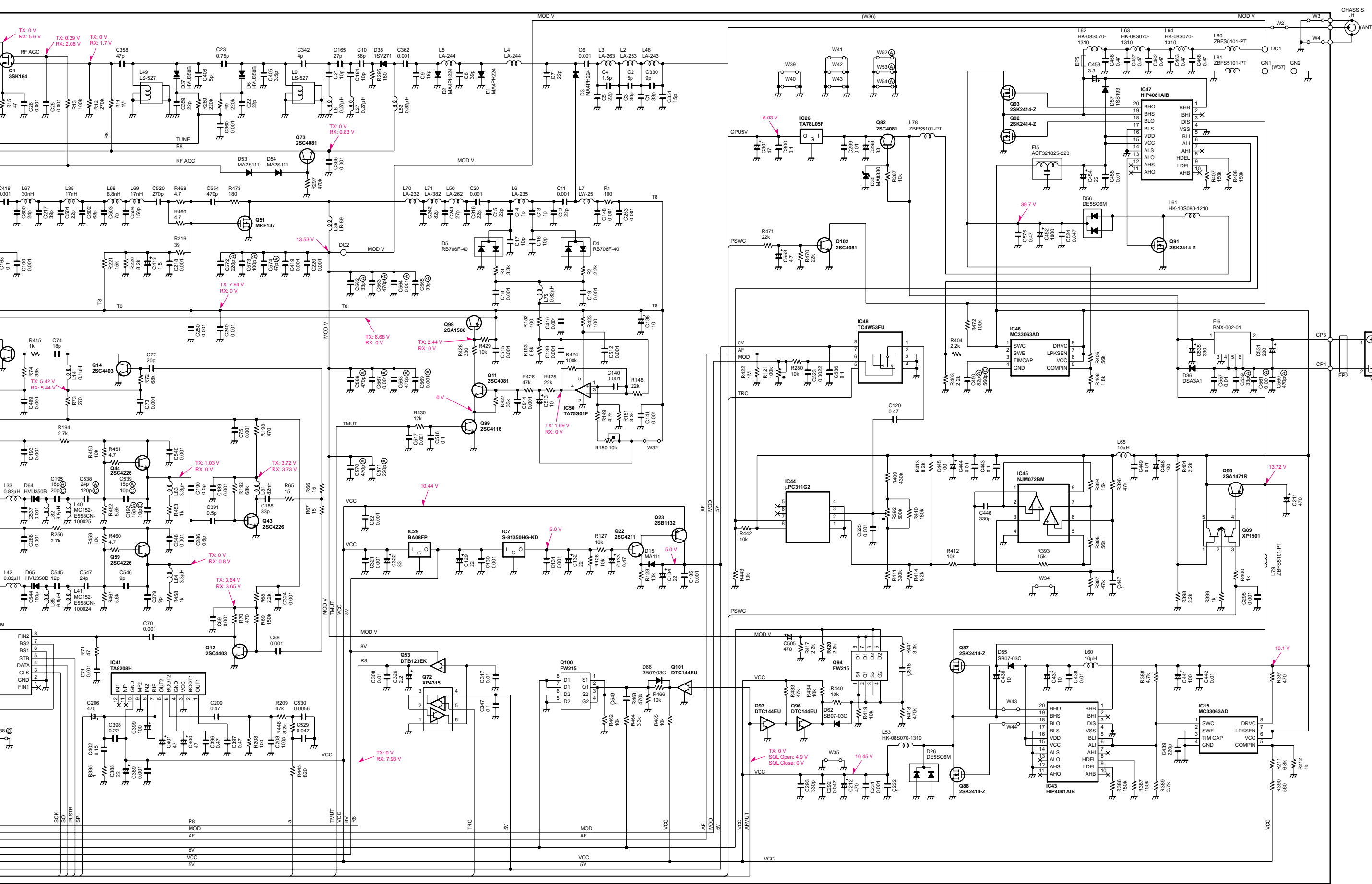

TX: 0.0V
RX: 5.8V

TX: 0.39V
RX: 2.08V

TX: 0.0V
RX: 1.7V

TX: 0.0V
RX: 0.83V

TX: 7.94V
RX: 0.0V

TX: 5.42V
RX: 5.44V

TX: 1.03V
RX: 0.0V

TX: 3.72V
RX: 3.73V

TX: 0.0V
RX: 0.8V

TX: 3.64V
RX: 3.65V

TX: 0.0V
RX: 7.93V

TX: 2.44V
RX: 0.0V

TX: 1.69V
RX: 0.0V

TX: 8.68V
RX: 0.0V

TX: 5.03V

TX: 39.7V

TX: 10.44V

TX: 5.0V

TX: 5.0V

TX: 5.0V

TX: 10.45V

TX: 4.9V

TX: 10.5V

TX: 10.1V

CHASSIS

J1 (ANT)

W2

W3

W4

DC1

GN1 (W37)

GN2

W5

W6

W7

W8

W9

W10

W11

W12

W13

W14

W15

W16

W17

W18

W19

W20

W21

W22

W23

W24

W25

W26

W27

W28

W29

W30

W31

W32

W33

W34

W35

W36

W37

W38

W39

W40

W41

W42

W43

W44

W45

W46

W47

W48

W49

W50

W51

W52

W53

W54

W55

W56

W57

W58

W59

W60

W61

W62

W63

W64

W65

W66

W67

W68

W69

W70

W71

W72

W73

W74

W75

W76

W77

W78

W79

W80

W81

W82

W83

W84

W85

W86

W87

W88

W89

W90

W91

W92

W93

W94

W95

W96

W97

W98

W99

W100

10-2 MAIN UNIT

Note
 [A110EURO]
 [USA-1], [A110EURO]
 [A110]

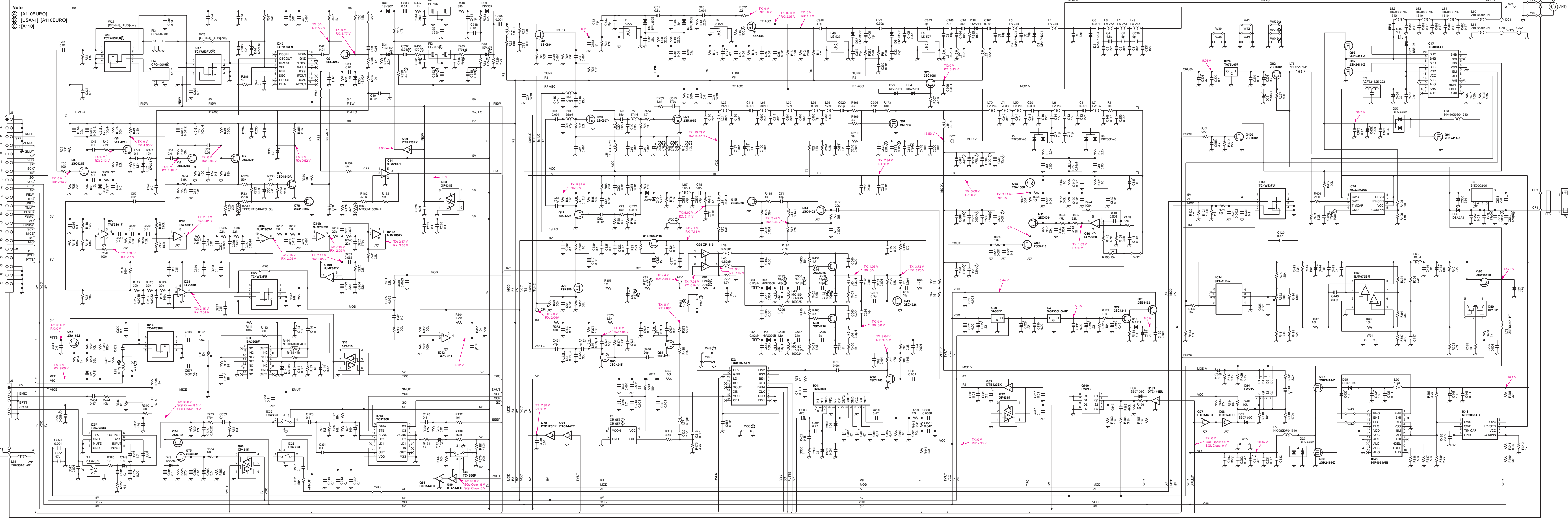

Icom Inc.

1-1-32, Kamiminami, Hirano-ku, Osaka 547-0003, Japan
Phone : 06 6793 5302
Fax : 06 6793 0013
URL : <http://www.icom.co.jp/world/index.html>

Icom America Inc.

<Corporate Headquarters>
2380 116th Avenue N.E., Bellevue, WA 98004, U.S.A.
Phone : (425) 454-8155 Fax : (425) 454-1509
URL : <http://www.icomamerica.com>
<Customer Service>
Phone : (425) 454-7619

Icom Canada

Glenwood Centre #150-6165
Highway 17 Delta, B.C., V4K 5B8, Canada
Phone : (604) 952-4266 Fax : (604) 952-0090
URL : <http://www.icomcanada.com>

Icom (Australia) Pty. Ltd.

A.B.N. 88 006 092 575
290-294 Albert Street, Brunswick, Victoria, 3056, Australia
Phone : 03 9387 0666 Fax : 03 9387 0022
URL : <http://www.icom.net.au>

Icom New Zealand

146A Harris Road, East Tamaki,
Auckland, New Zealand
Phone : 09 274 4062 Fax : 09 274 4708
URL : <http://www.icom.co.nz>

Icom (Europe) GmbH

Communication Equipment
Himmelgeister Str. 100, D-40225 Düsseldorf, Germany
Phone : 0211 346047 Fax : 0211 333639
URL : <http://www.icomeurope.com>

Icom Spain S.L

Ctra. de Gracia a Manresa Km. 14,750
08190 Sant Cugat del Valles Barcelona, SPAIN
Phone : (93) 590 26 70 Fax : (93) 589 04 46
URL : <http://www.icomspain.com>

Icom (UK) Ltd.

Unit 9, Sea St., Herne Bay, Kent, CT6 8LD, U.K.
Phone : 01227 741741 Fax : 01227 741742
URL : <http://www.icomuk.co.uk>

Icom France S.a

Zac de la Plaine, Rue Brindejonc des Moulinais
BP 5804, 31505 Toulouse Cedex, France
Phone : 561 36 03 03 Fax : 561 36 03 00
URL : <http://www.icom-france.com>

Asia Icom Inc.

6F No. 68, Sec. 1 Cheng-Teh Road, Taipei, Taiwan, R.O.C.
Phone : (02) 2559 1899 Fax : (02) 2559 1874

Count on us!

Icom Inc.

1-1-32, Kamiminami, Hirano-ku, Osaka 547-0003, Japan

S-13608HZ-C1-②

© 2001 Icom Inc.